

**Preparation of pictorial illustrations on access  
to water supply and sanitation facilities  
for use in national household surveys**

**Final report (revised)**

Prepared for the  
Joint Monitoring Programme on Water Supply and Sanitation (JMP)  
World Health Organization (WHO) and United Nations Children's Fund (UNICEF)

*Rod Shaw*

*Team Leader, Information and Resources Team  
Water, Engineering and Development Centre (WEDC)  
Loughborough University*

June 2005



Water, Engineering and Development Centre  
Loughborough University  
Leicestershire  
LE11 3TU UK

Telephone: +44 (0) 1509 222886

Fax: +44 (0) 1509 211079

Email: [R.J.Shaw@lboro.ac.uk](mailto:R.J.Shaw@lboro.ac.uk)

Illustrations: Rod Shaw

## Introduction

This report has been prepared for the Joint Monitoring Programme on Water Supply and Sanitation (JMP) of the World Health Organization (WHO) and the United Nations Children's Fund (UNICEF) as part of a project to develop pictorial illustrations on access to water supply and sanitation facilities for use in national household surveys.

The report presents the final illustrations on 22 water supply and sanitation themes and is the conclusion of the project as detailed in the Terms of Reference. It follows on from the inception report submitted in September 2004, the progress report submitted in November 2004 and the final report submitted in May 2005

After submission of the inception and progress reports, the proposed use of the illustrations was revised. As a result of the concerns raised about pictorial understanding at household level, it was noted that the illustrations would be best employed as a tool to help train the household survey interviewers. As the interviewers will not necessarily be technical people, it was concluded that the style of the illustrations should remain simple, as originally envisaged. Some understanding of the conventions for depicting sub-surface levels in technical illustrations might be expected, however, although it was noted that such conventions should be limited to the themes for which there is no obvious alternative means of depiction.

A number of additional images drawn from the WEDC Image Library are also presented in this report following the suggestion that, in some instances, more than one image of a particular facility would be helpful.

The following are enclosed along with this revised final report, thus concluding all objectives:

- High resolution electronic versions of the illustrations
- Additional materials

The final illustrations and additional materials are presented on a CD in folders and sub-folders relating to each theme. e.g:

### **S02 – Septic tank**

#### **Illustrations**

**Additional illustrations** (*contains supplementary files not pictured in this report*)

Flush toilet to a septic tank (a).tif (*file pictured in this report*)

Flush toilet to a septic tank (b).tif (*file pictured in this report*)

**Photographs** (*contains supplementary files not pictured in this report*)

*Please note: Photographs and additional illustrations are unavailable for some themes.*

## **The illustrations**

### **Water supply facilities**

- W1. Piped water into a dwelling
- W2. Piped water to yard/plot
- W3. Public tap/standpipe
- W4. Tubewell/borehole
- W5. Protected dug well
- W6. Unprotected dug well
- W7. Protected spring
- W8. Rainwater
- W9. Bottled water
- W10. Small-scale vendor
- W11. Tanker-truck
- W12. Surface water

### **Sanitation facilities**

- S1. Flush toilet to a piped sewer system
- S2. A septic tank
- S3. Flush/pour flush to pit
- S4. Composting toilet
- S5. VIP latrine
- S6. Pit latrine with slab
- S7. Pit latrine without slab
- S8. Bucket
- S9. Hanging toilet
- S10. Open defecation

Please note: Captions correspond to the electronic filenames of the illustrations supplied at high resolution in tif format.

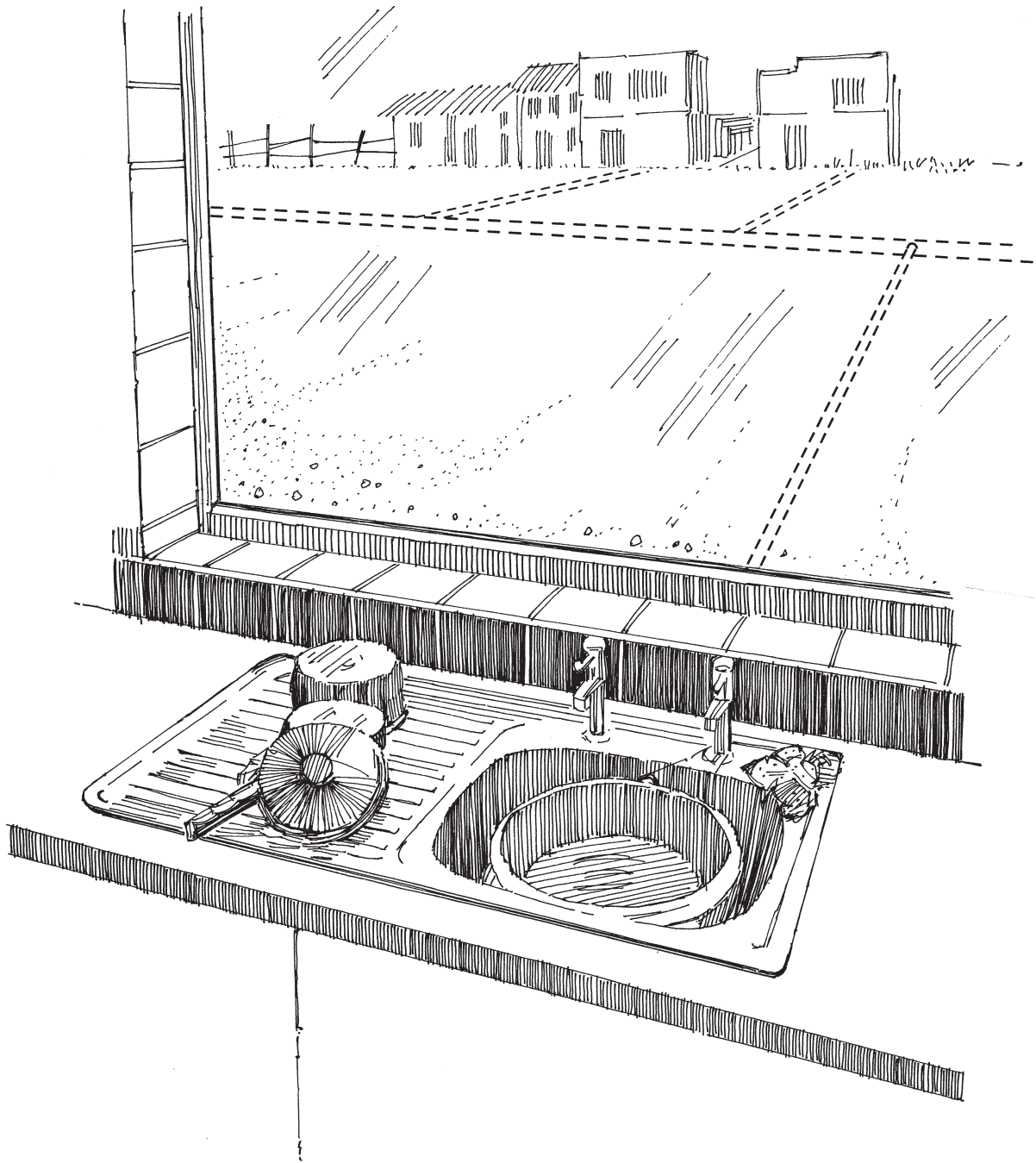

Pipe connections

**W1 - Piped water into a dwelling**

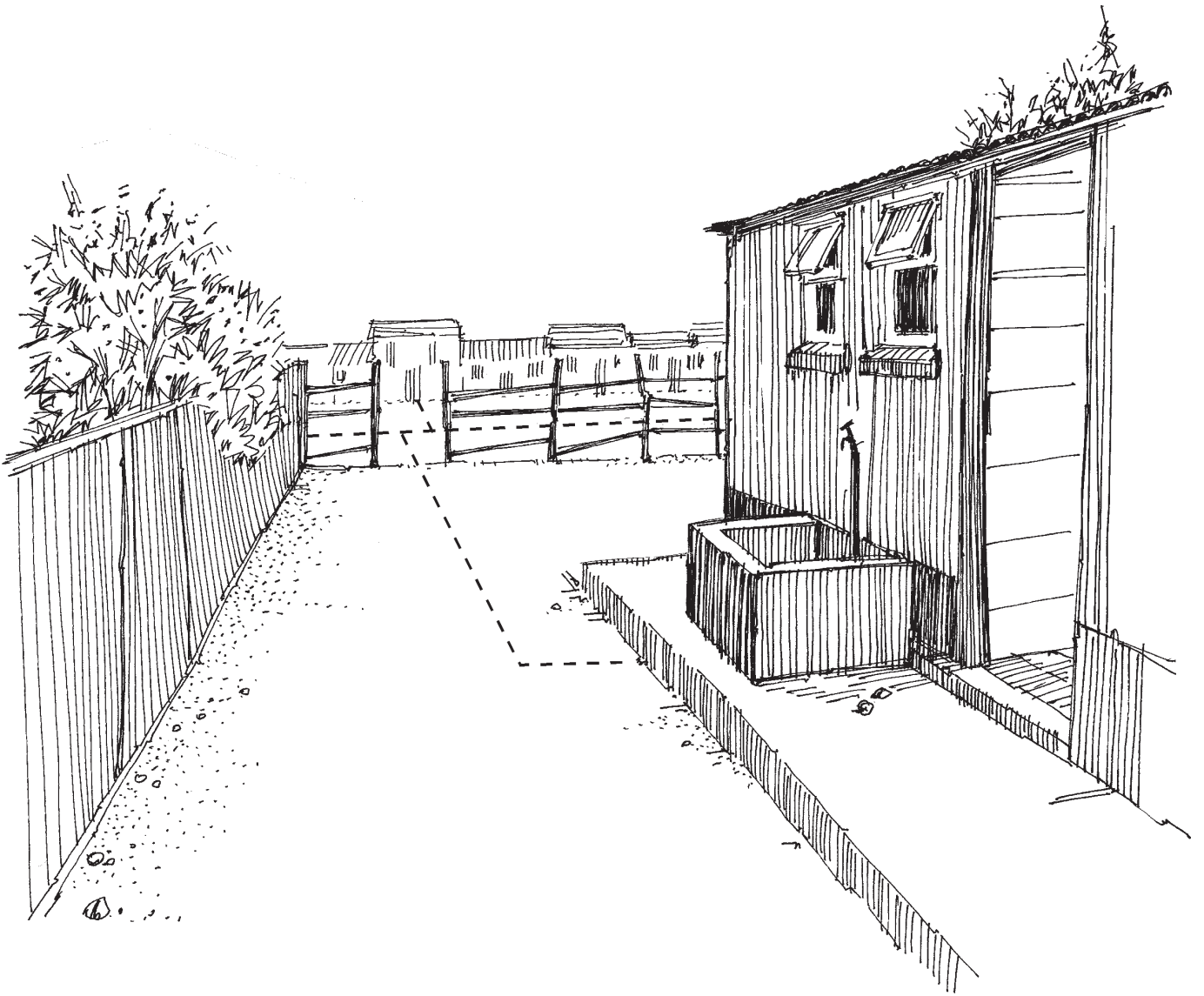

Piped water to yard

**W2 - Piped water to yard/plot**



Woman filling a jerrycan at a standpost

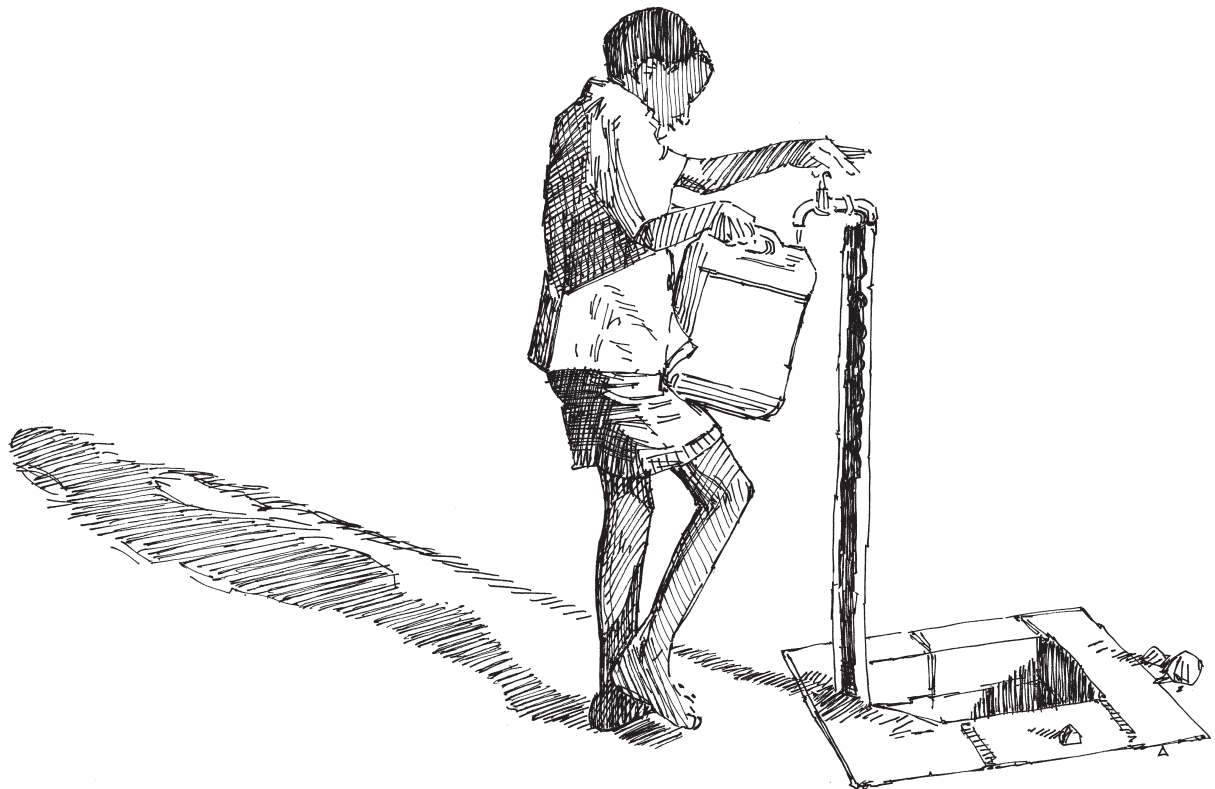

Boy at a standpost

### W3 - Public tap/standpipe

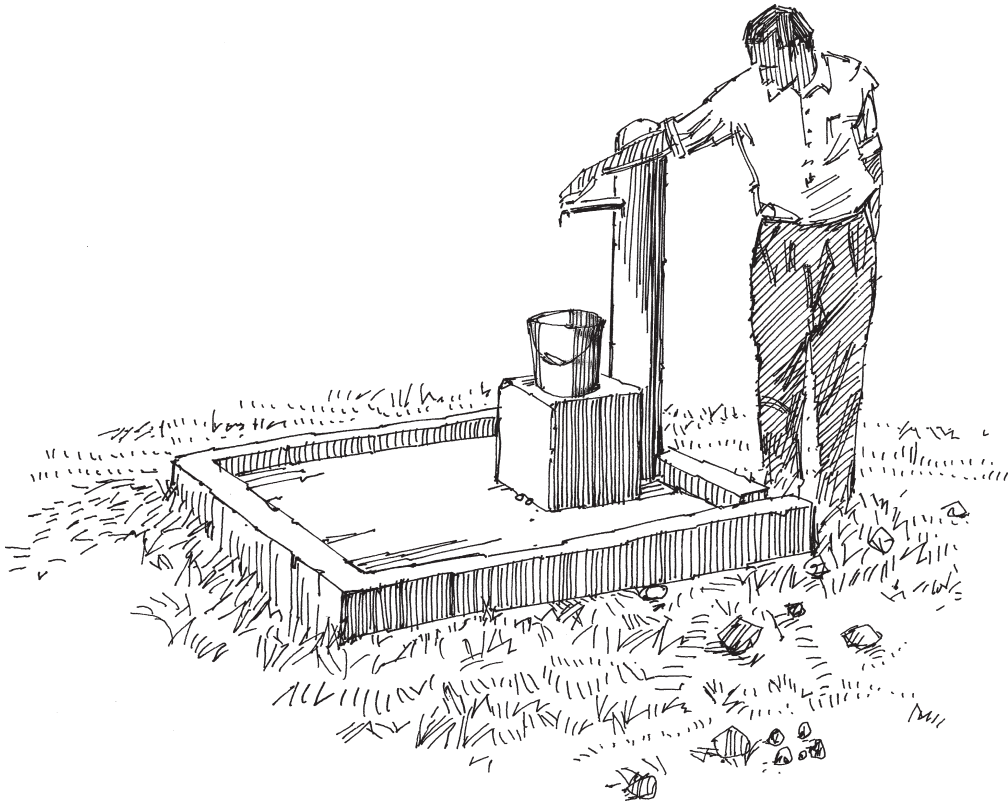

Man at a standpost



Handwashing at a public standpost

### **W3 - Public tap/standpipe**



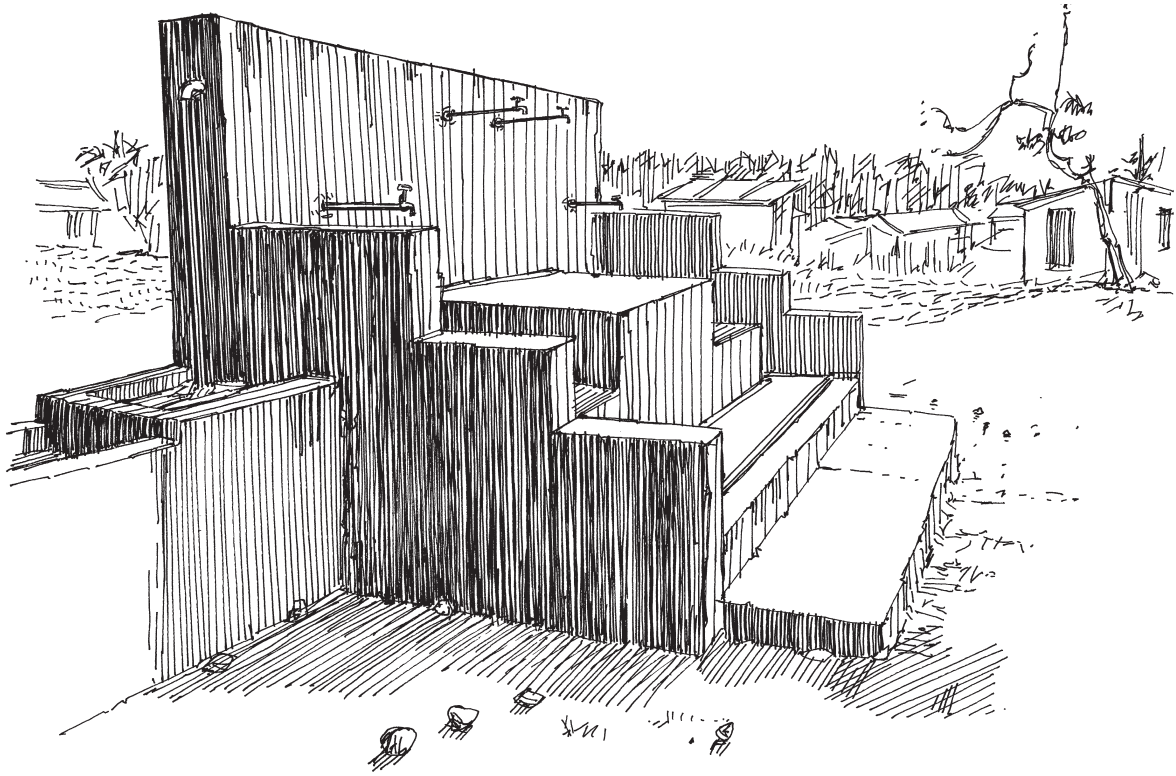

Public standpost



Woman loading water onto her back at a standpost

**W3 - Public tap/standpipe**



Woman filling a bucket from a handpump

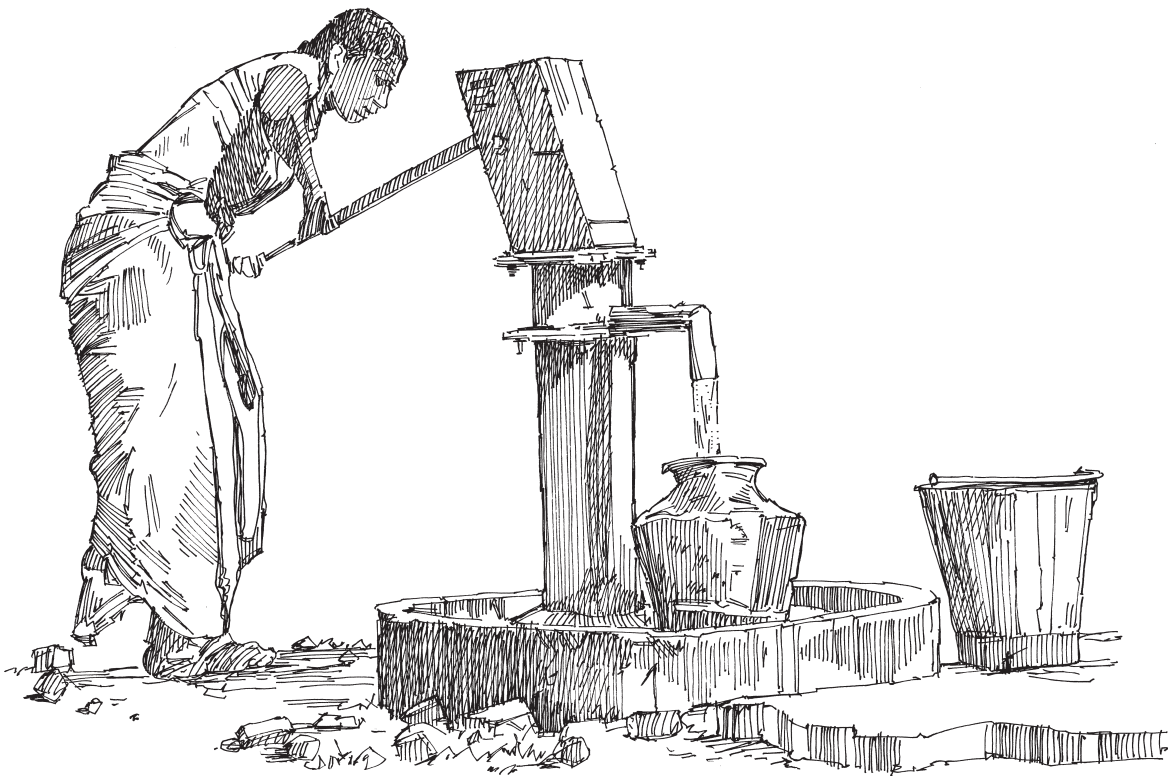

Woman using an India Mark II handpump

#### **W4 - Tubewell/borehole**

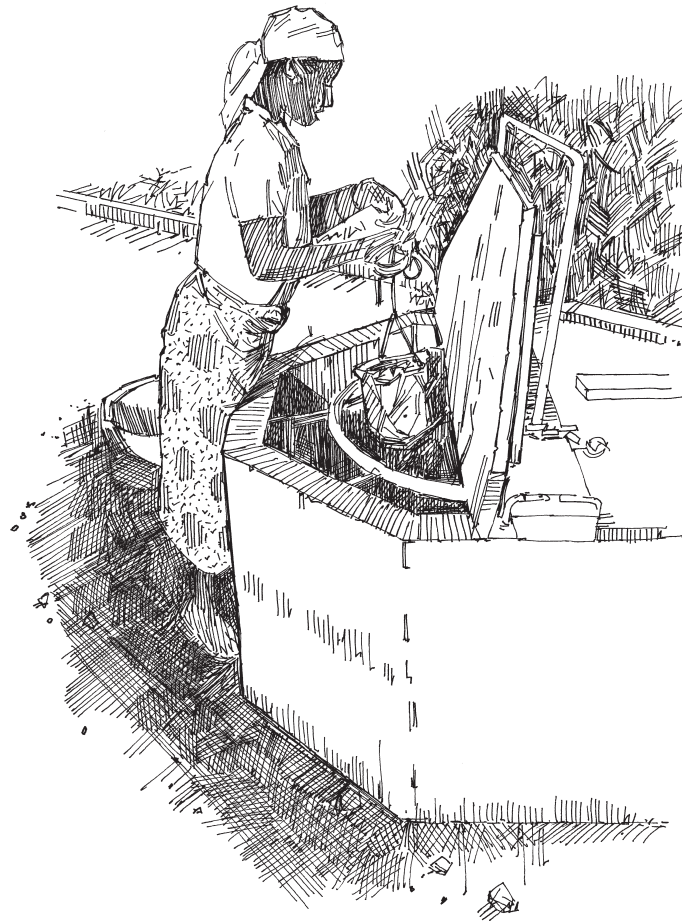

Covered well, hexagonal, Africa



Drawing water from a well 1

### W5 - Protected dug well

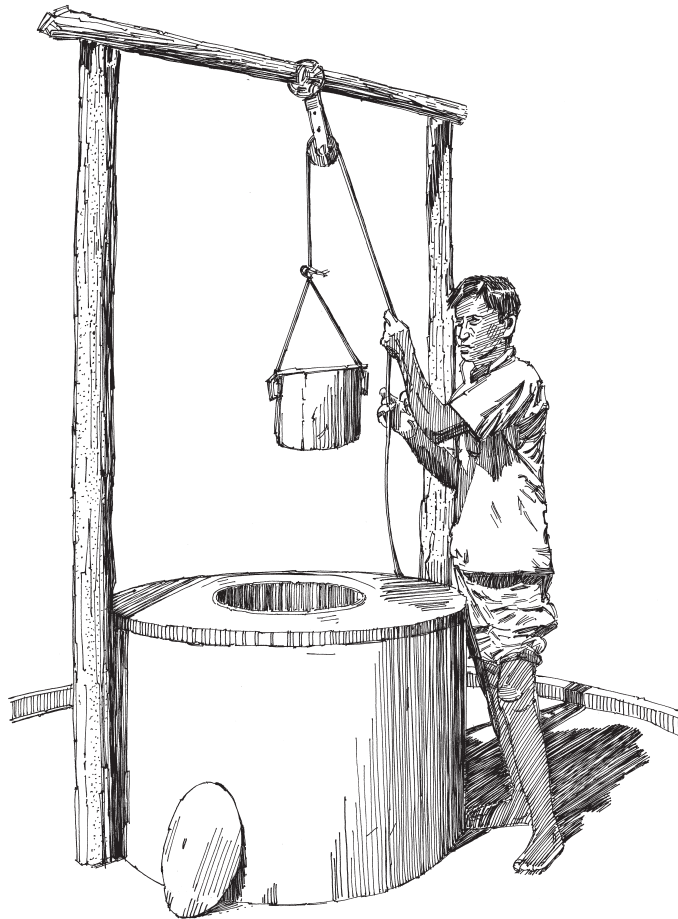

Drawing water from a protected well

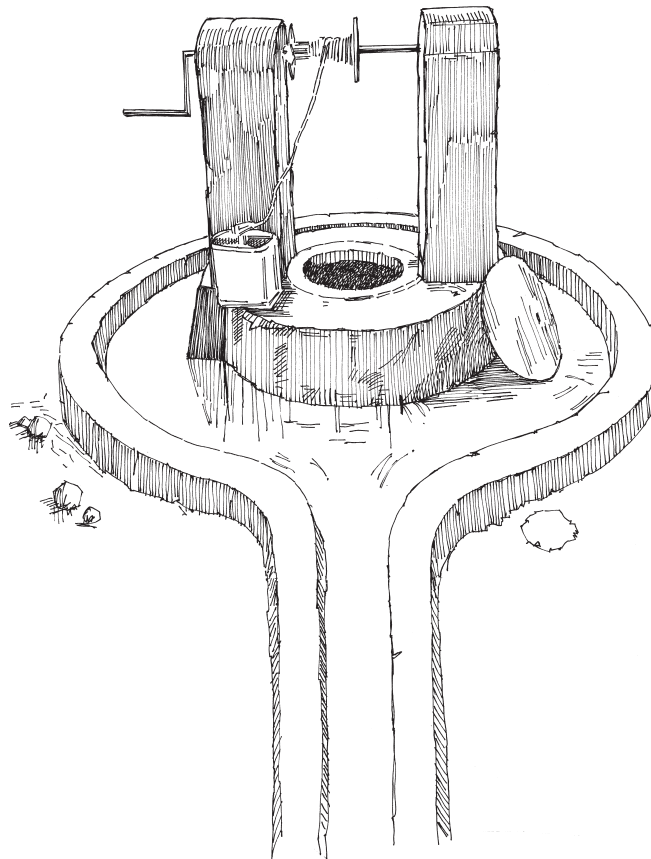

Upgraded well

### **W5 - Protected dug well**



Open well 1a



Open well 1b

**W6 - Unprotected dug well**

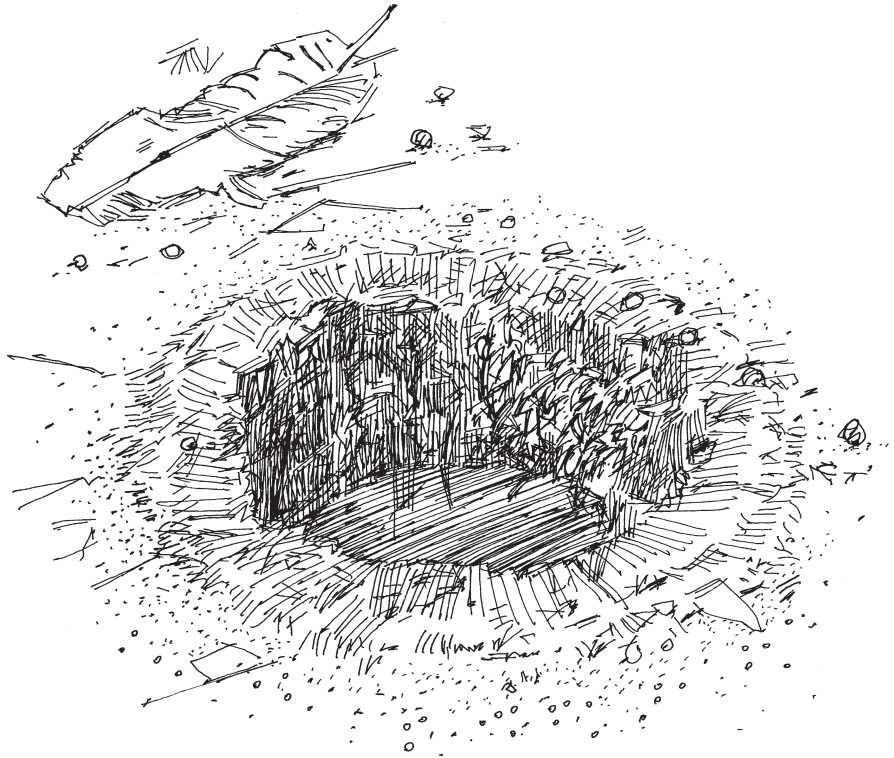

Open well 2

**W6 - Unprotected dug well**

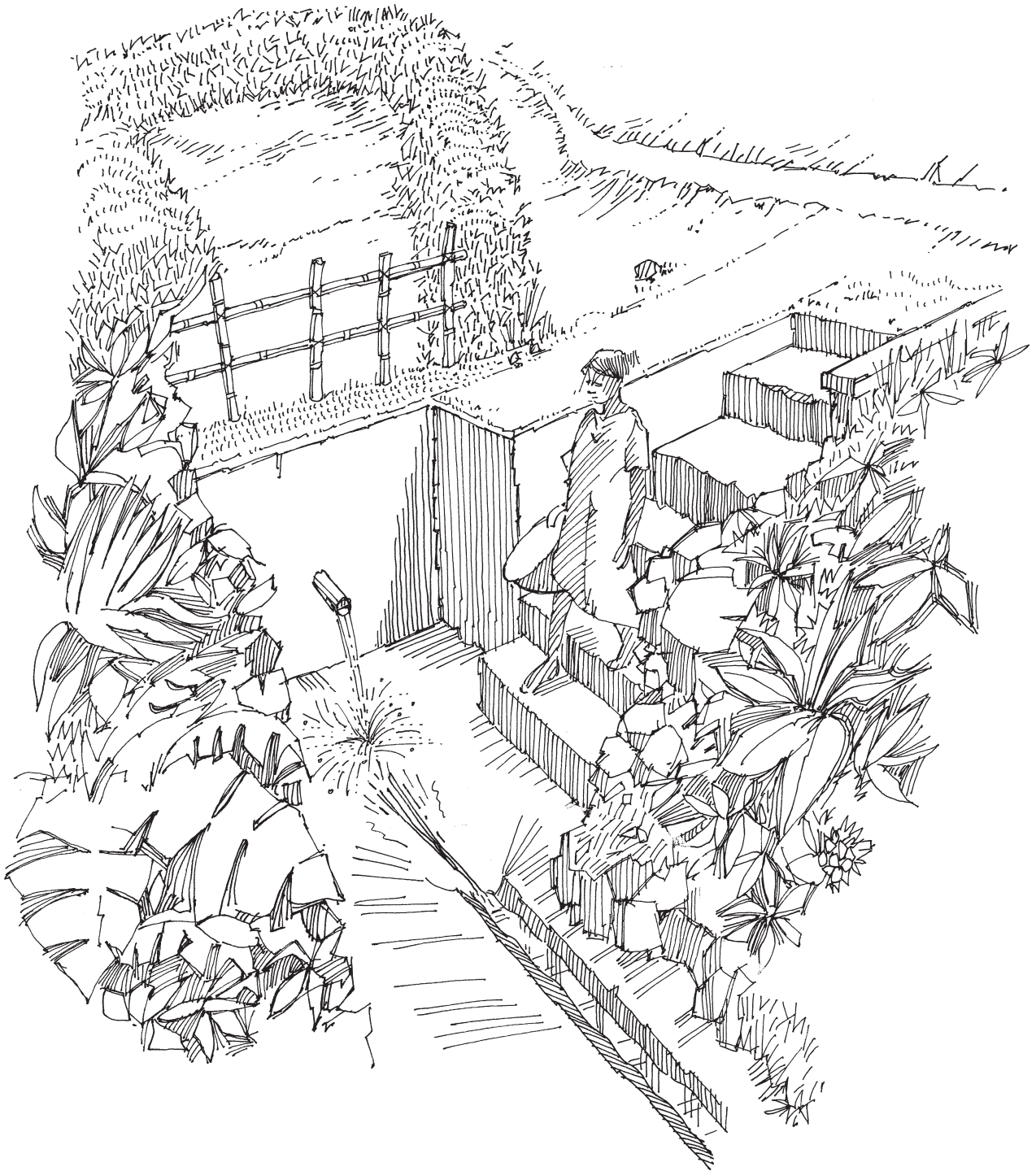

Protected spring with access steps

## W7 - Protected spring

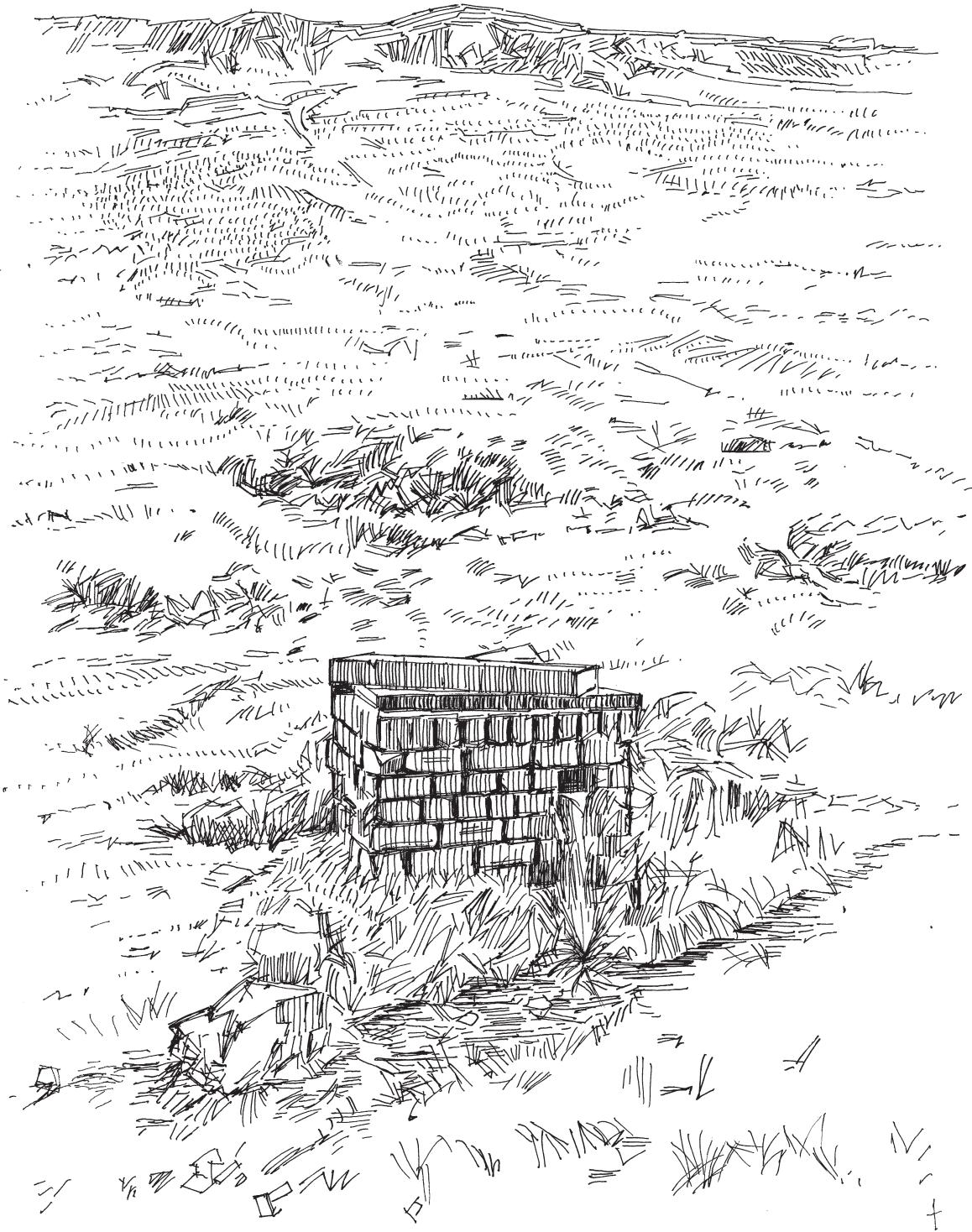

Spring box on a hillside

**W7 - Protected spring**



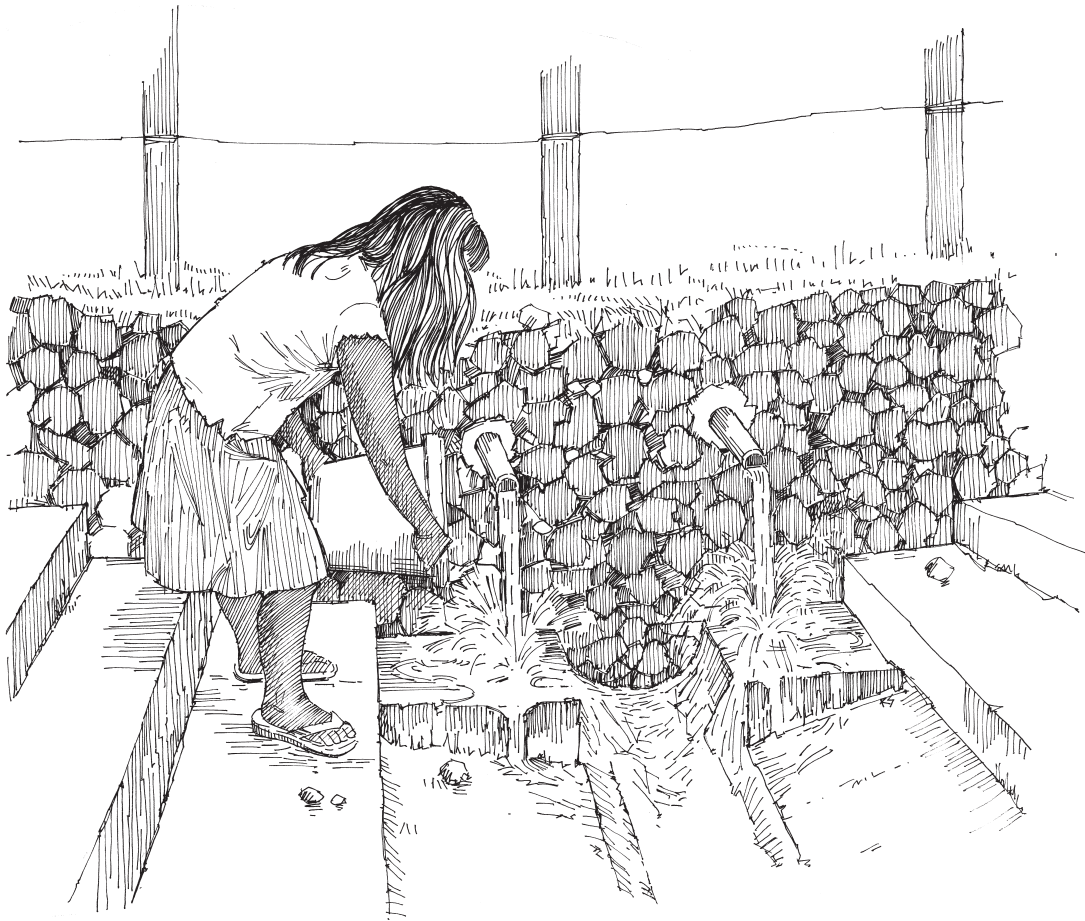

Collecting water from a protected spring

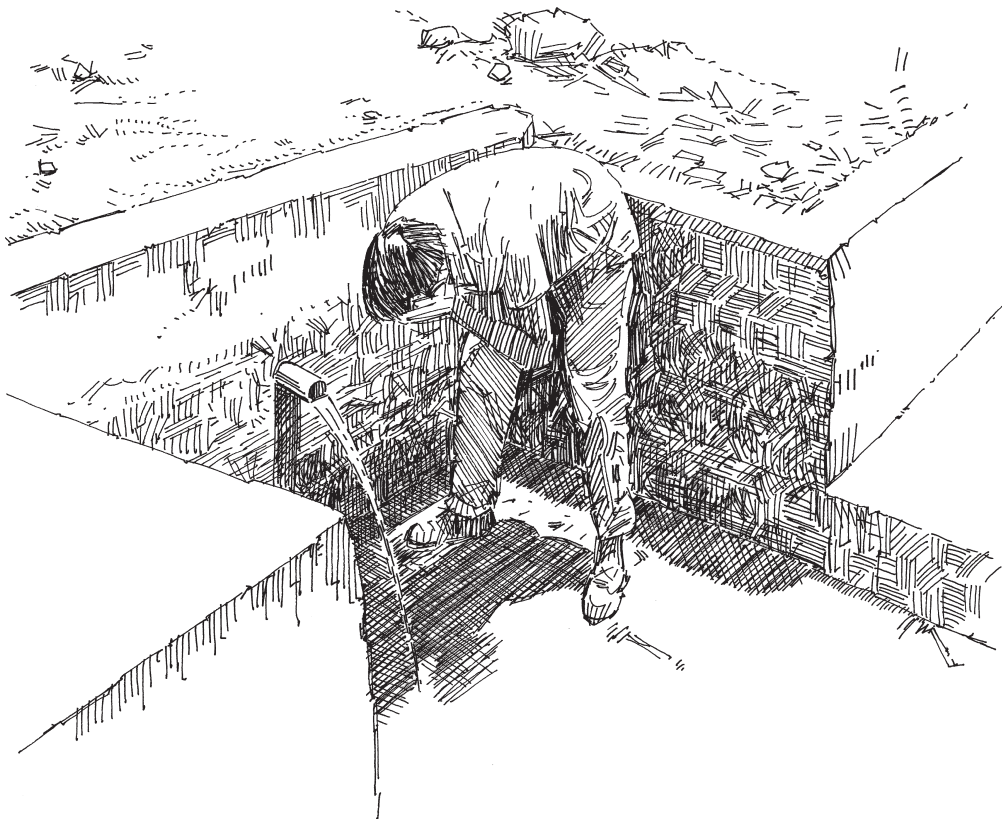

Washing at a spring

### **W7 - Protected spring**

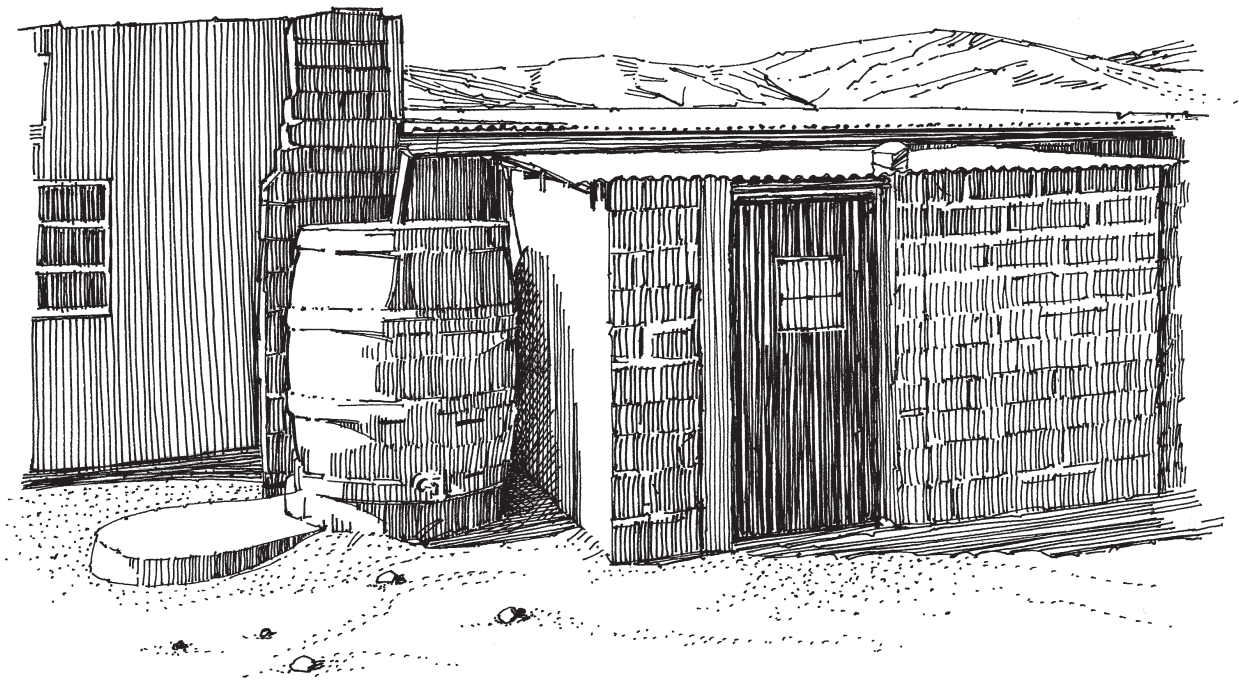

Rainwater collection 1



Rainwater collection 2

**W8 - Rainwater**

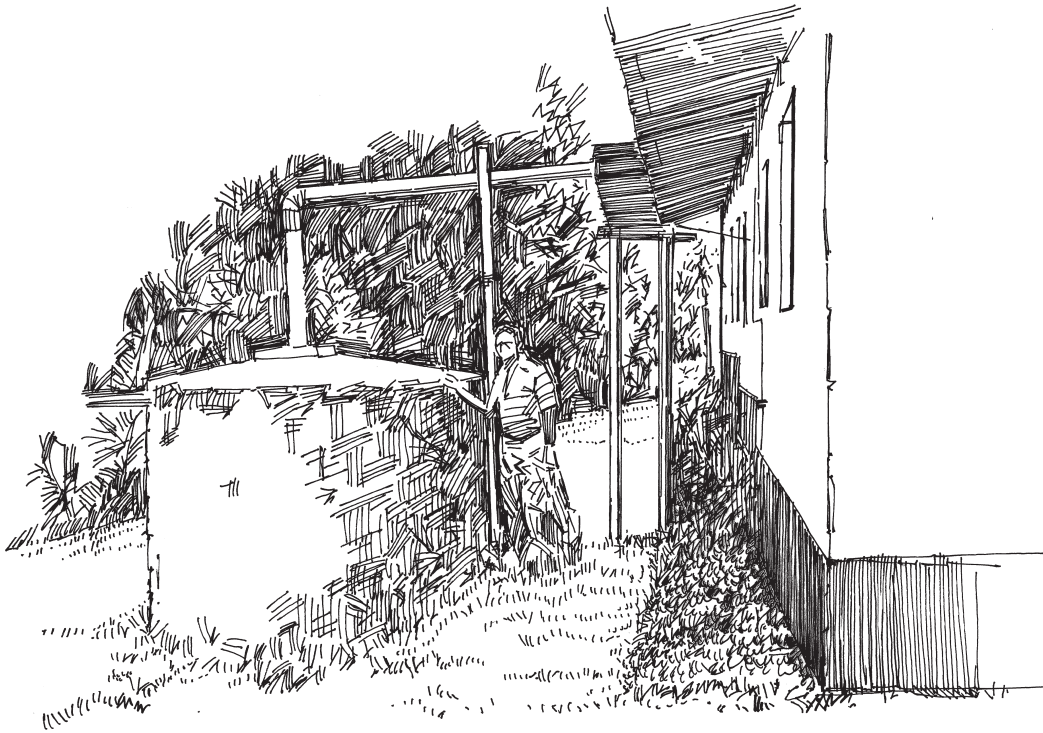

Rainwater collection 4

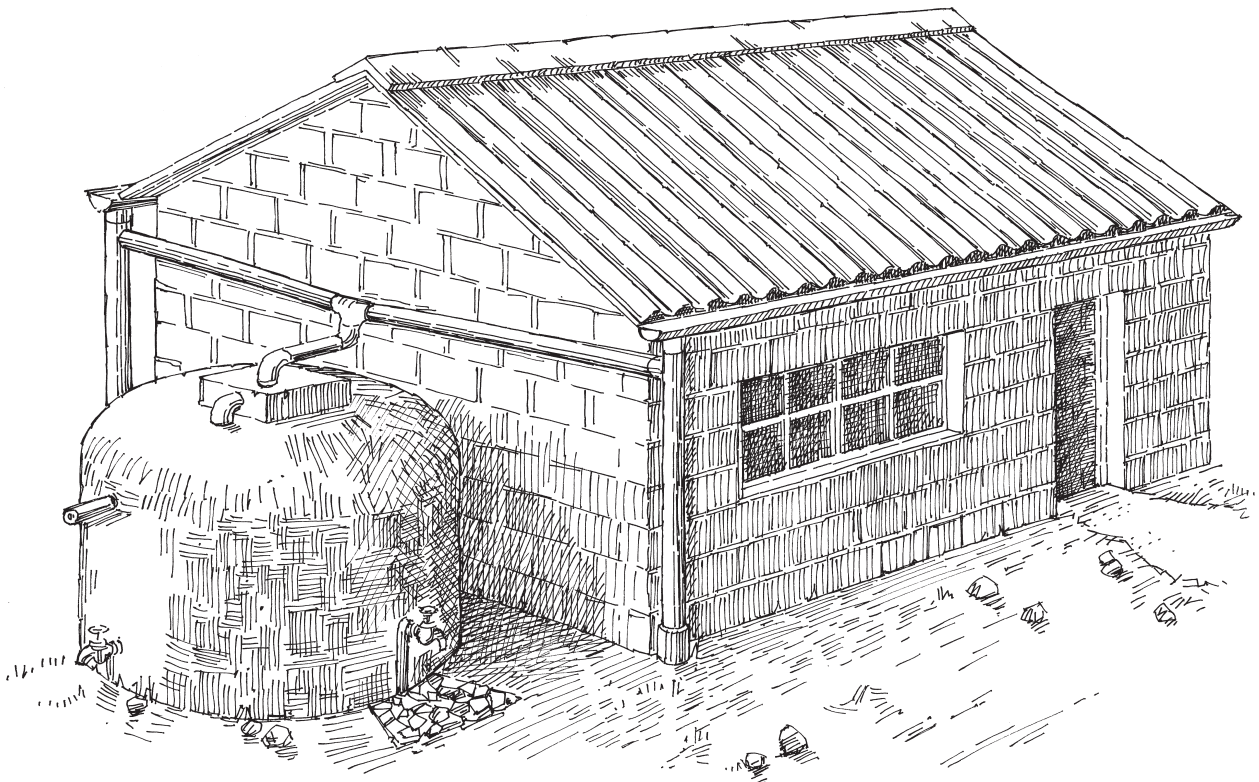

Rainwater collection 5

**W8 - Rainwater**



Bottle of water



Bottles of water

**W9 - Bottled water**



Pouring water from a bottle into a cup

## W9 - Bottled water



Selling water at a kiosk

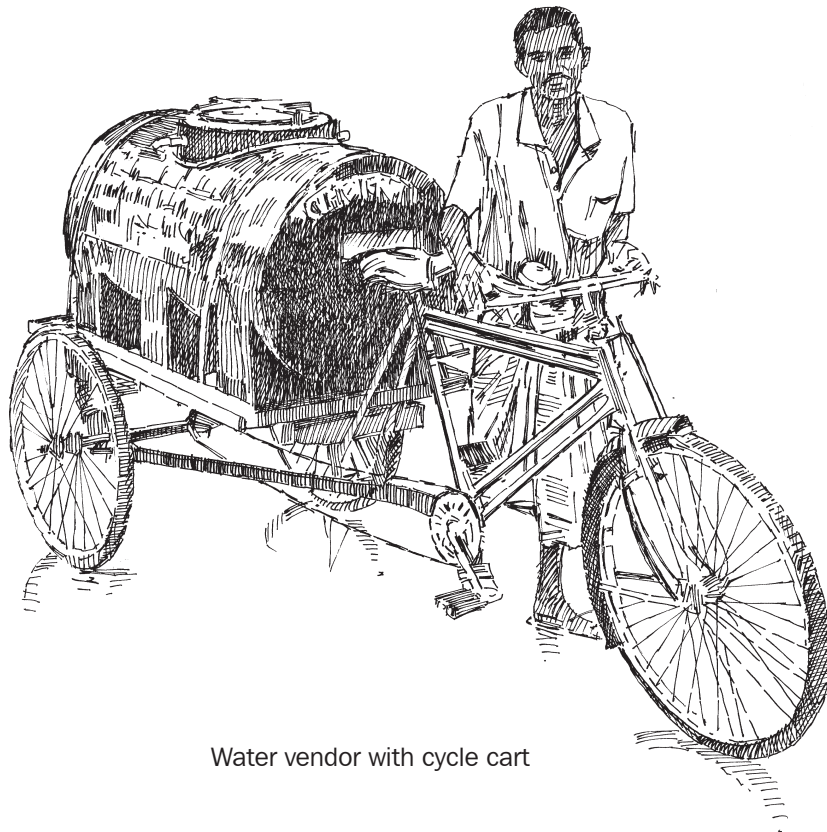

Water vendor with cycle cart

**W10 - Small-scale vendor**

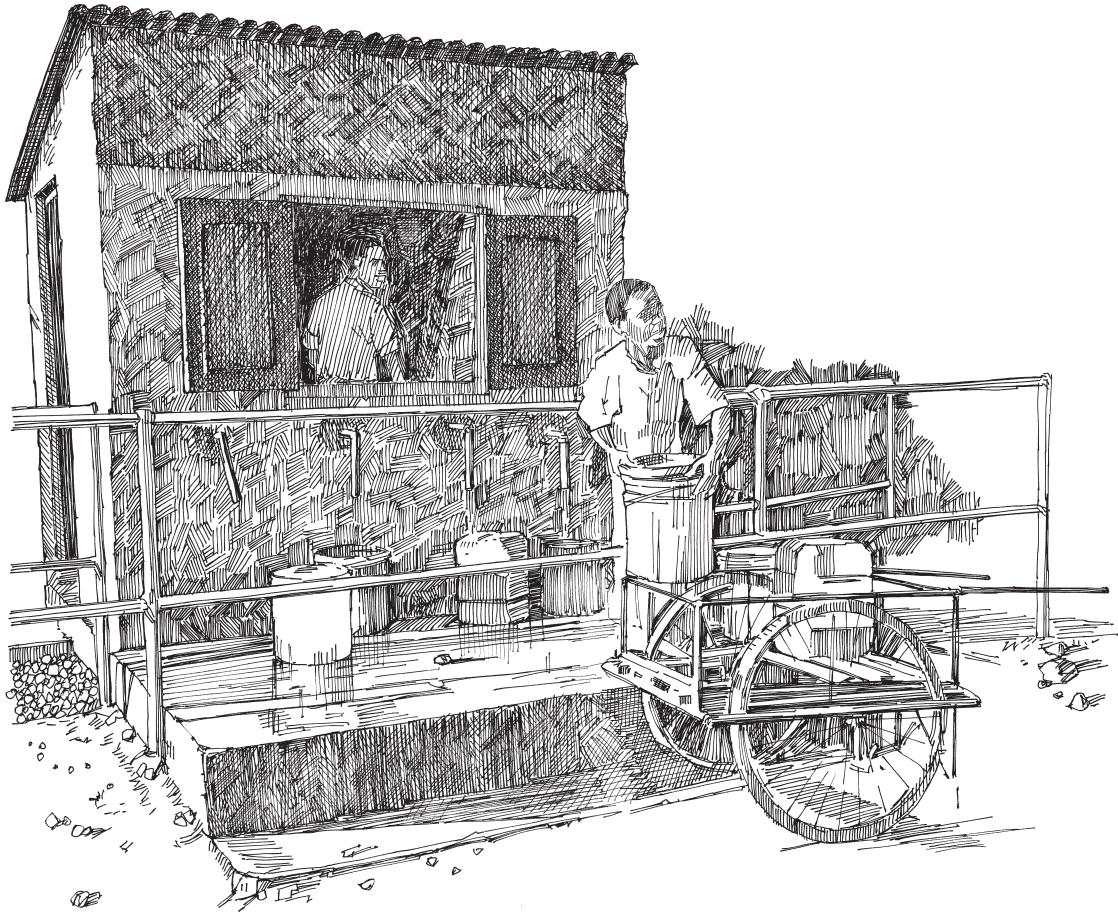

Water vending from a kiosk

**W10 - Small-scale vendor**

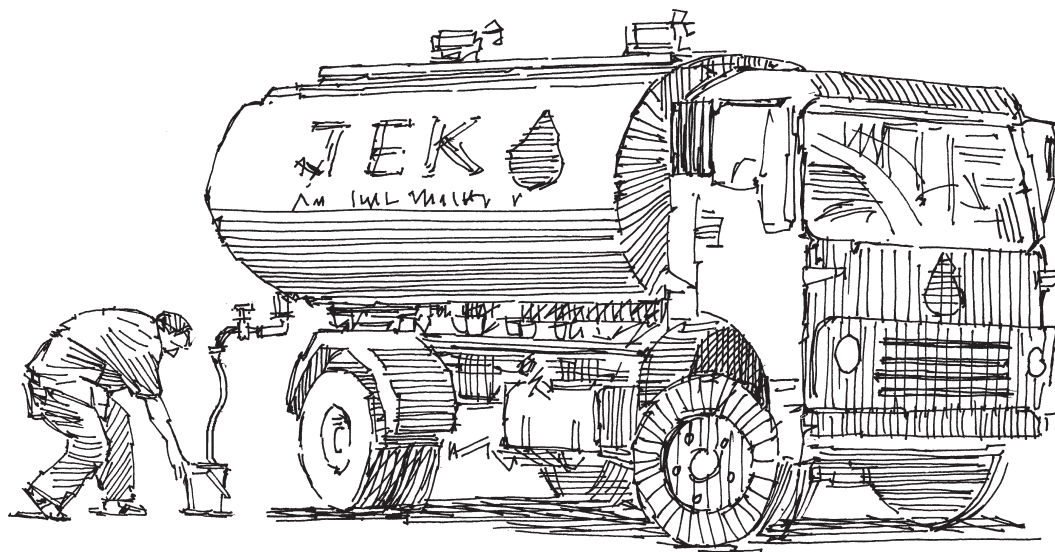

JEK water tanker

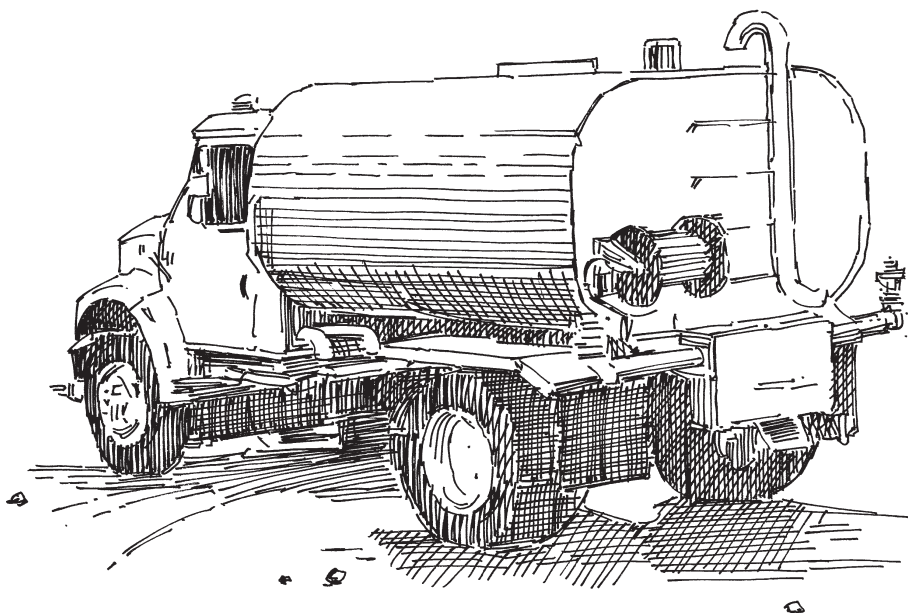

Water tanker

### W11 - Tanker-truck





Collecting water from a river

**W12 - Surface water**



Man and a woman by surface water

**W12 - Surface water**

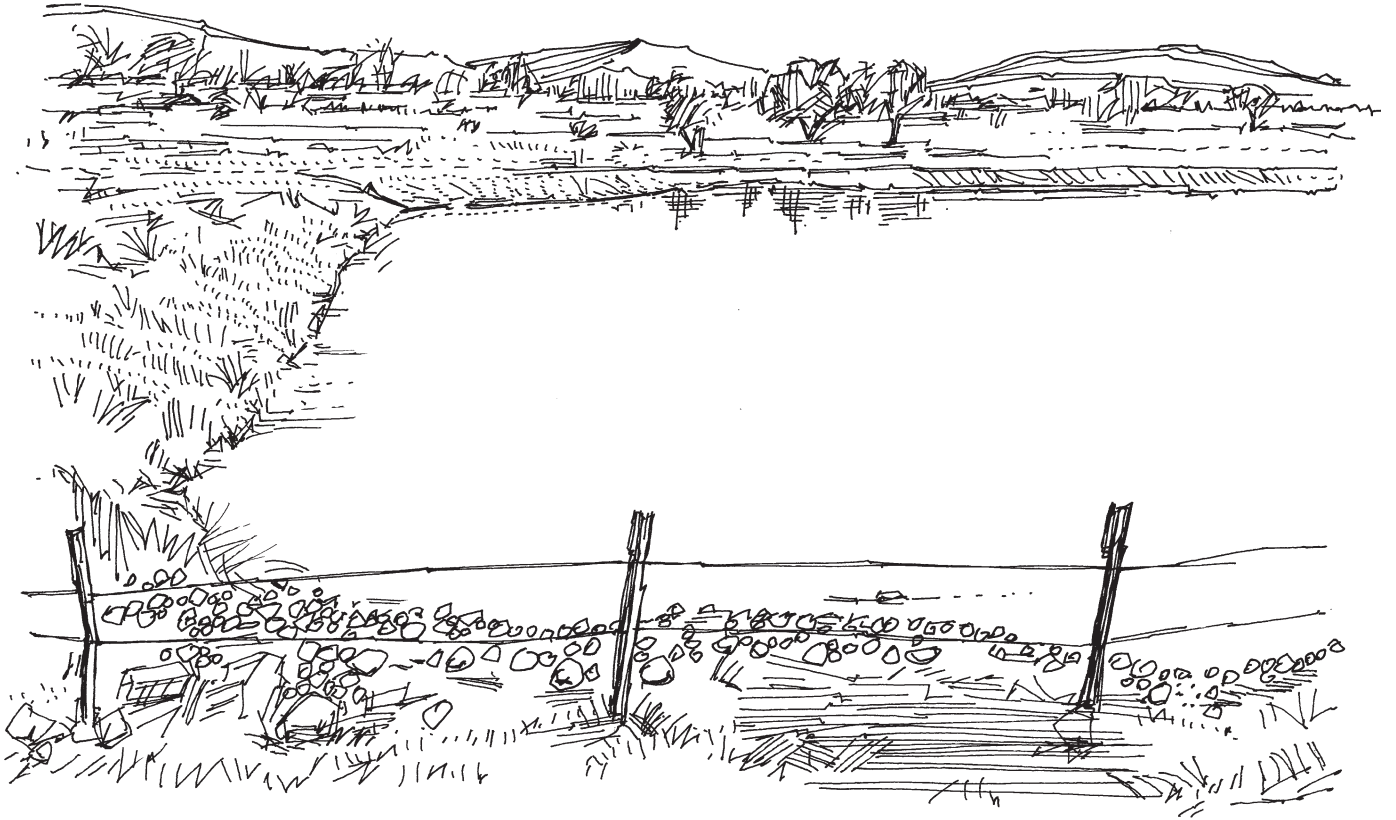

Surface water, fenced 1



Surface water, fenced 2

**W12 - Surface water**

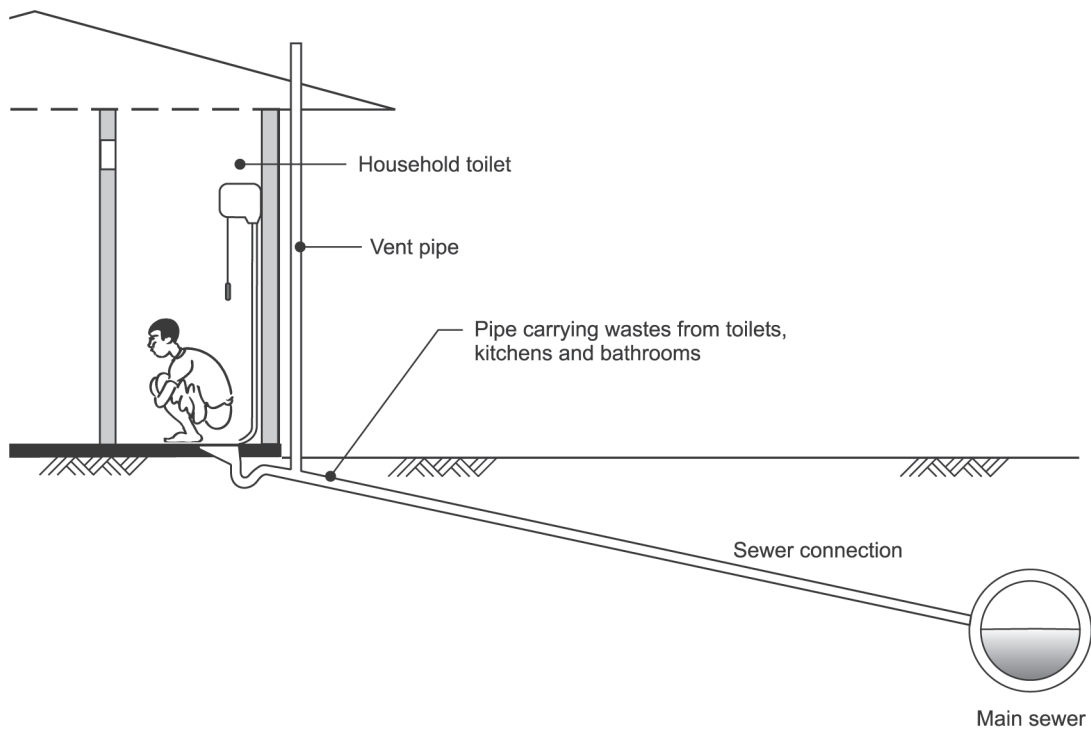

Flush toilet to a piped sewer system (a)

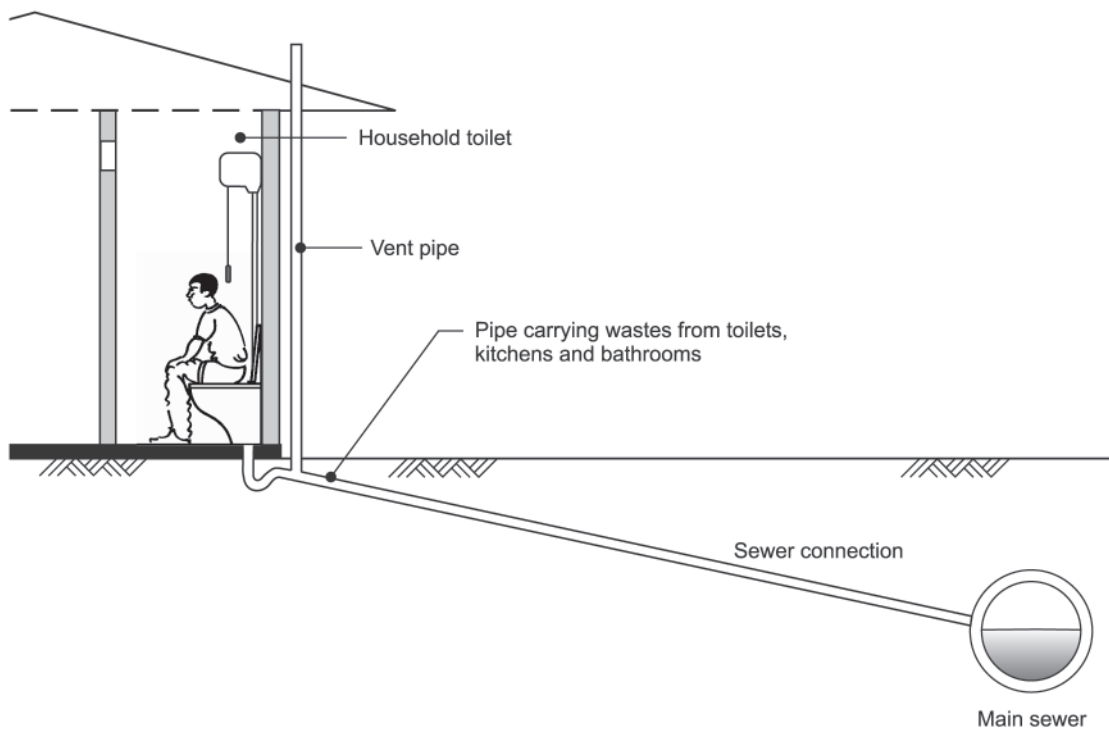

Flush toilet to a piped sewer system (b)

**S1 - Flush toilet to a piped sewer system**

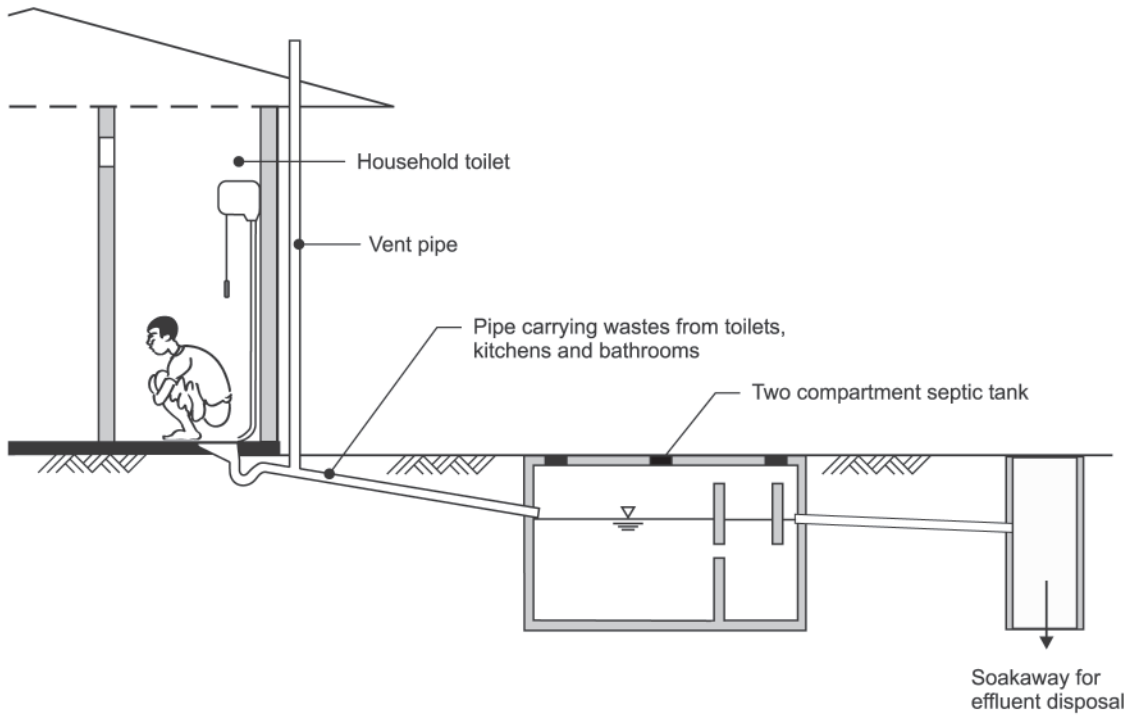

Pour-flush to a septic tank (a)

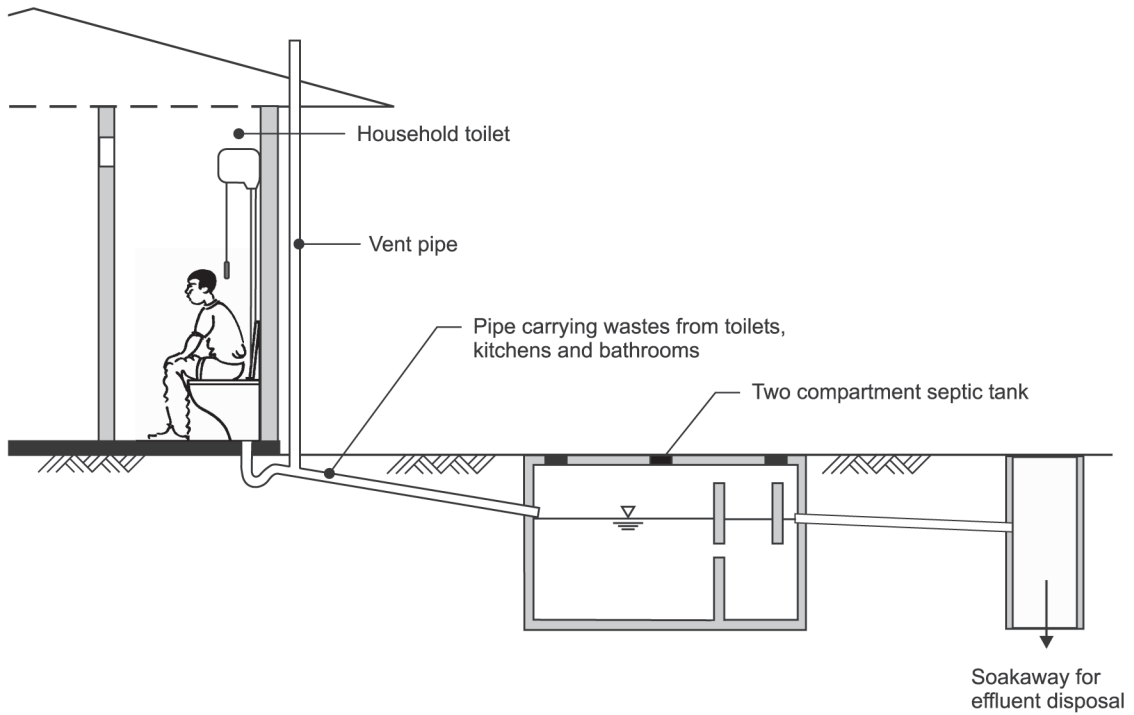

Pour-flush to a septic tank (b)

**S2 - Septic tank**



Pour-flush latrine (with figure)

**S3 - Pour-flush to pit**



Pour-flush latrine

**S3 - Pour-flush to pit**

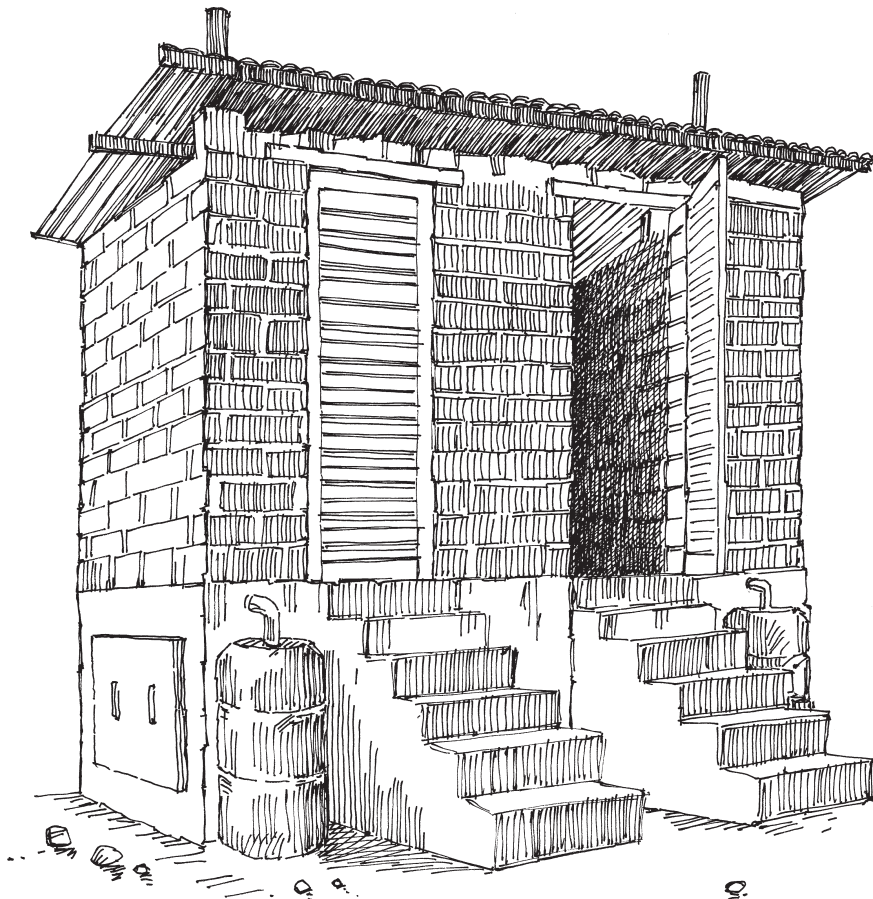

Compost latrines

**S4 - Composting toilet**



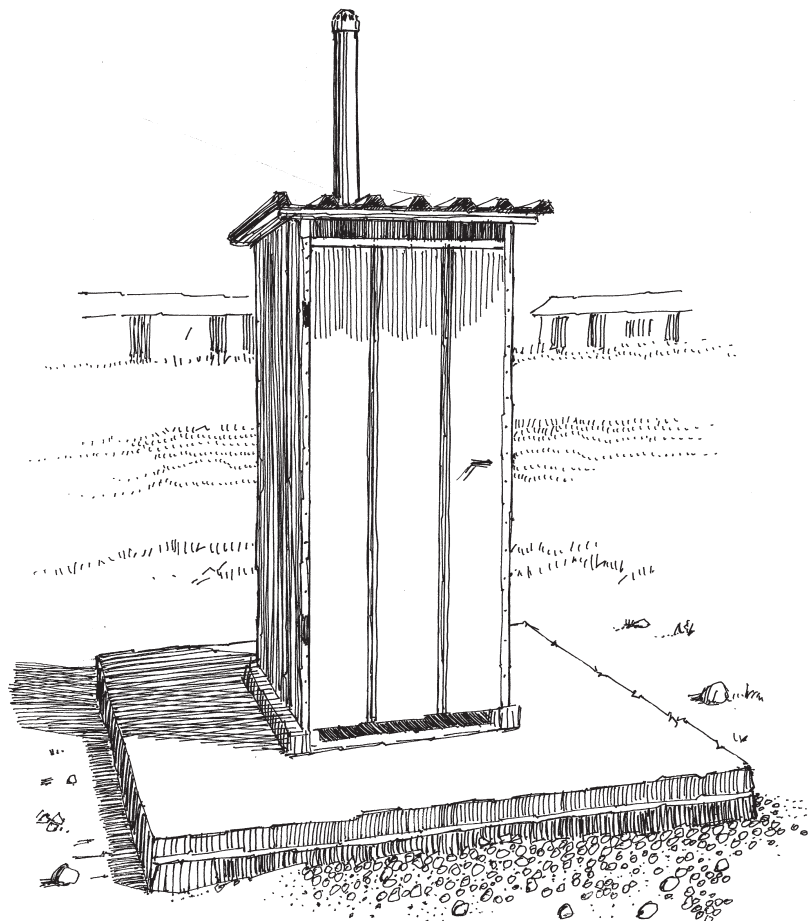

VIP latrine

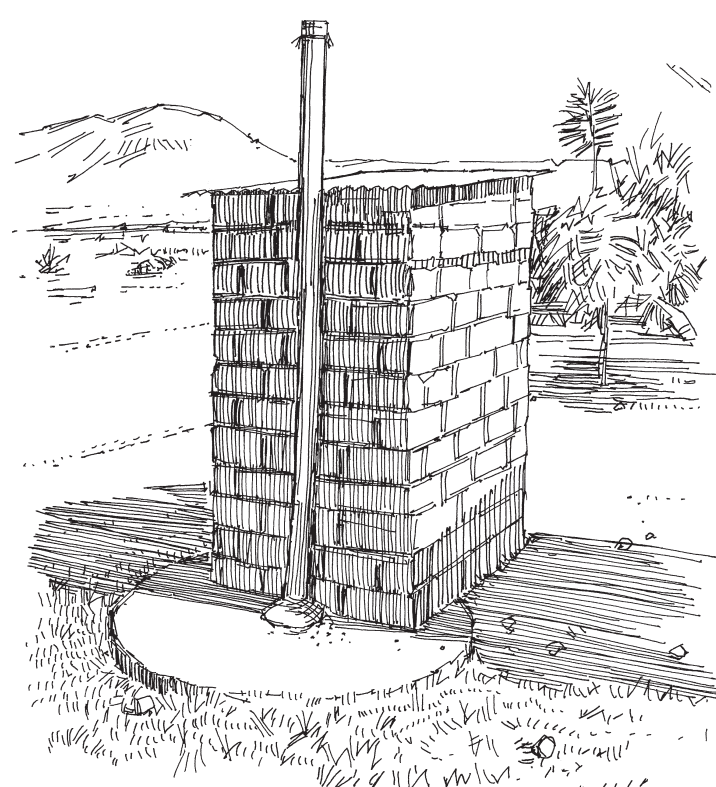

VIP latrine, offset

**S5 - VIP latrine**

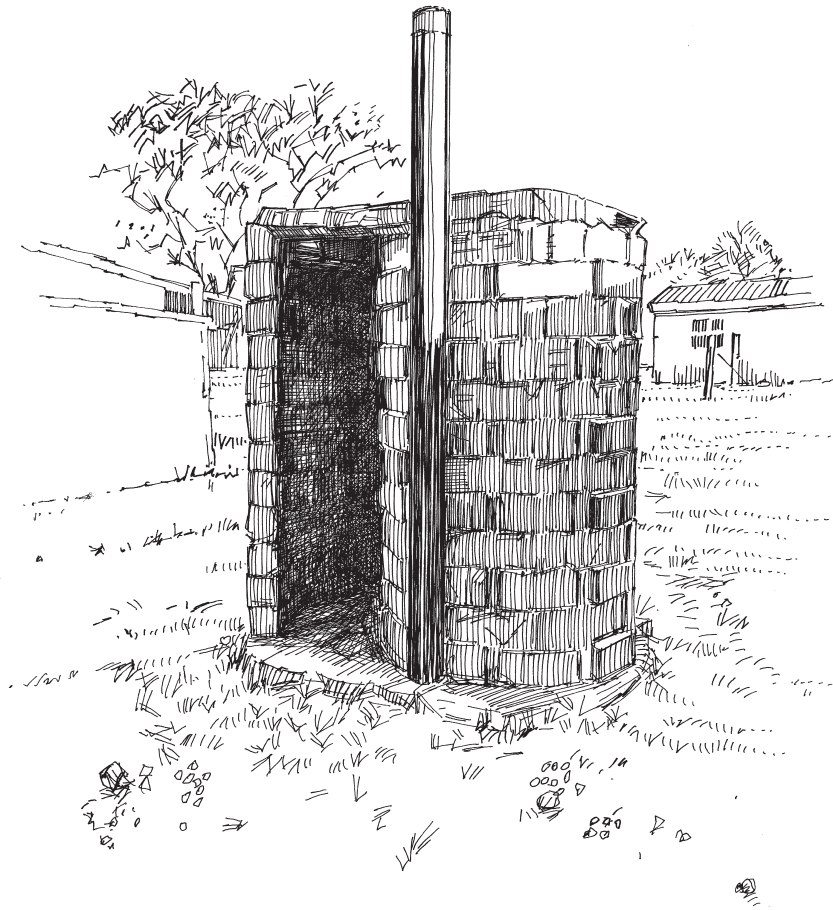

Spiral VIP latrine with vent pipe 1

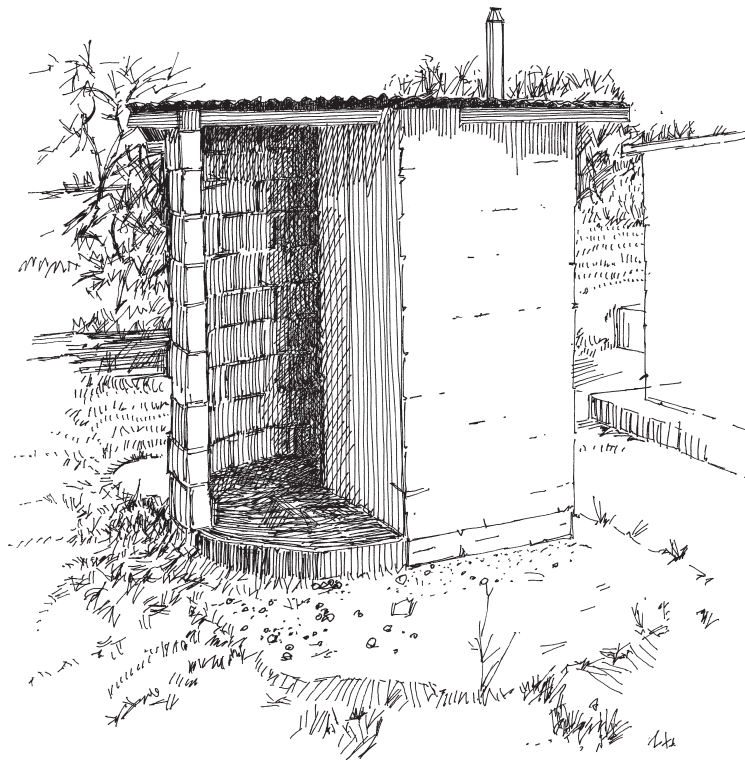

Spiral VIP latrine with vent pipe 2

**S5 - VIP latrine**

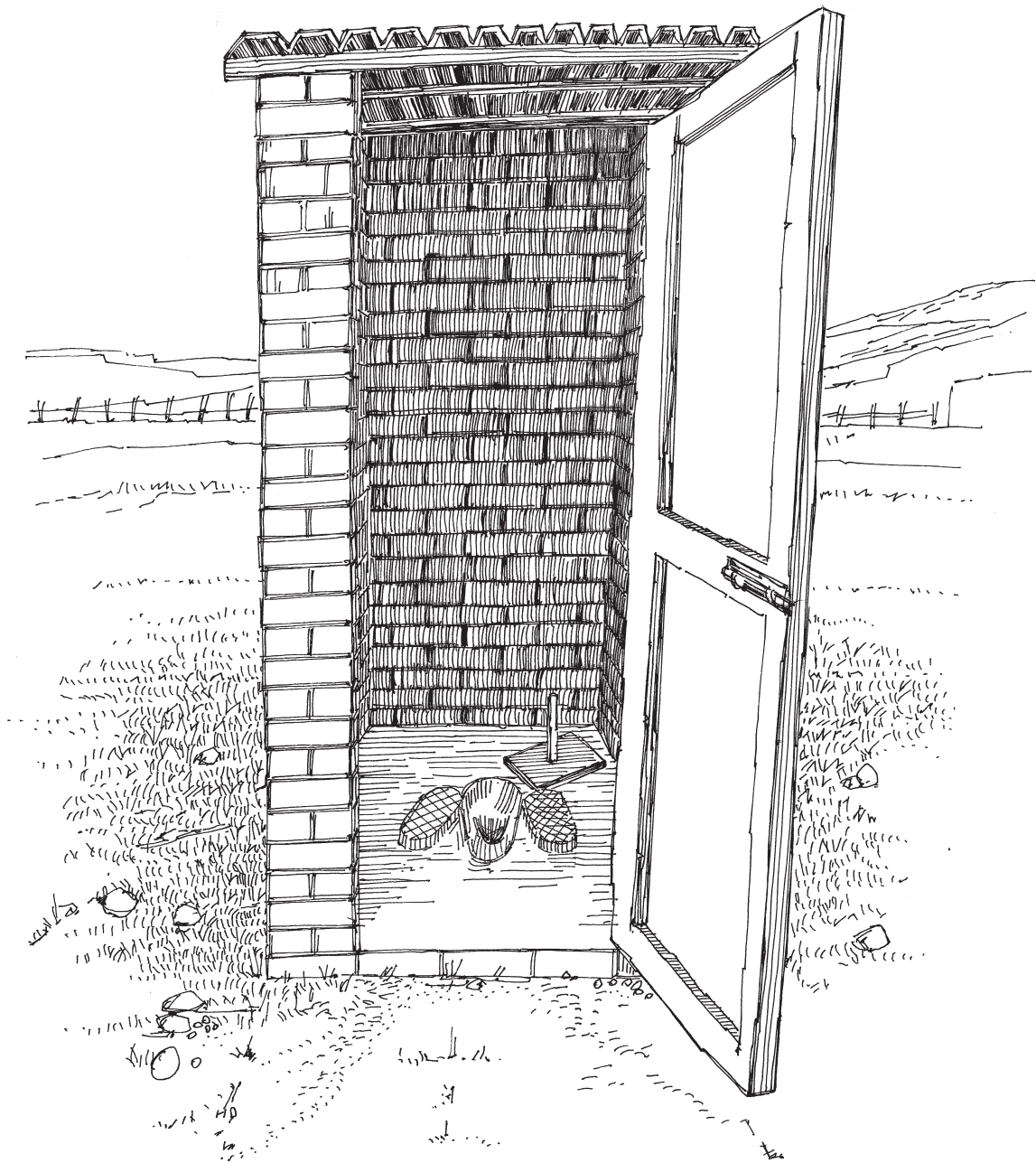

Simple pit latrine with hole cover

**S6 - Pit latrine with slab**

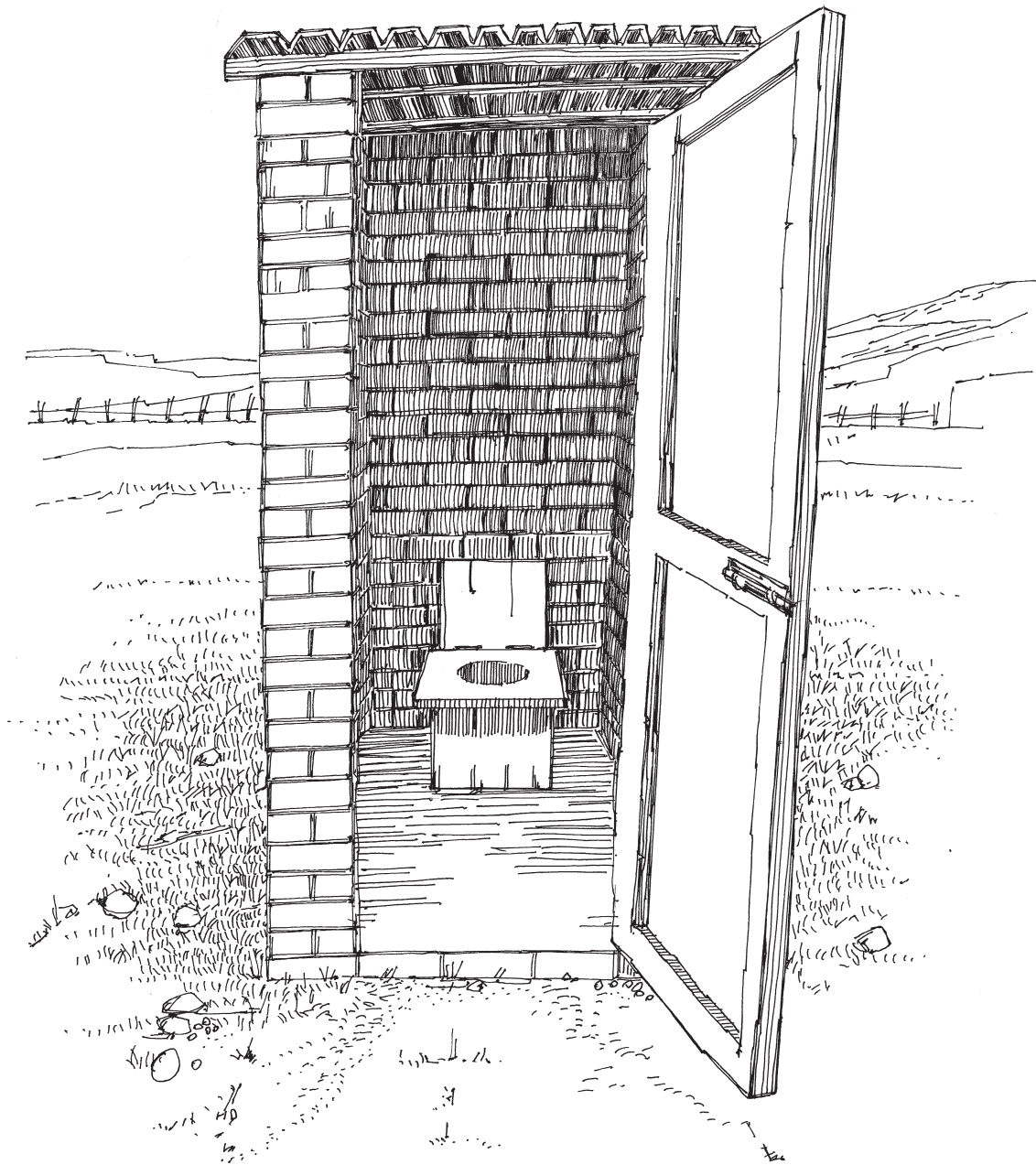

Simple pit latrine with seat and seat cover

### S6 - Pit latrine with slab

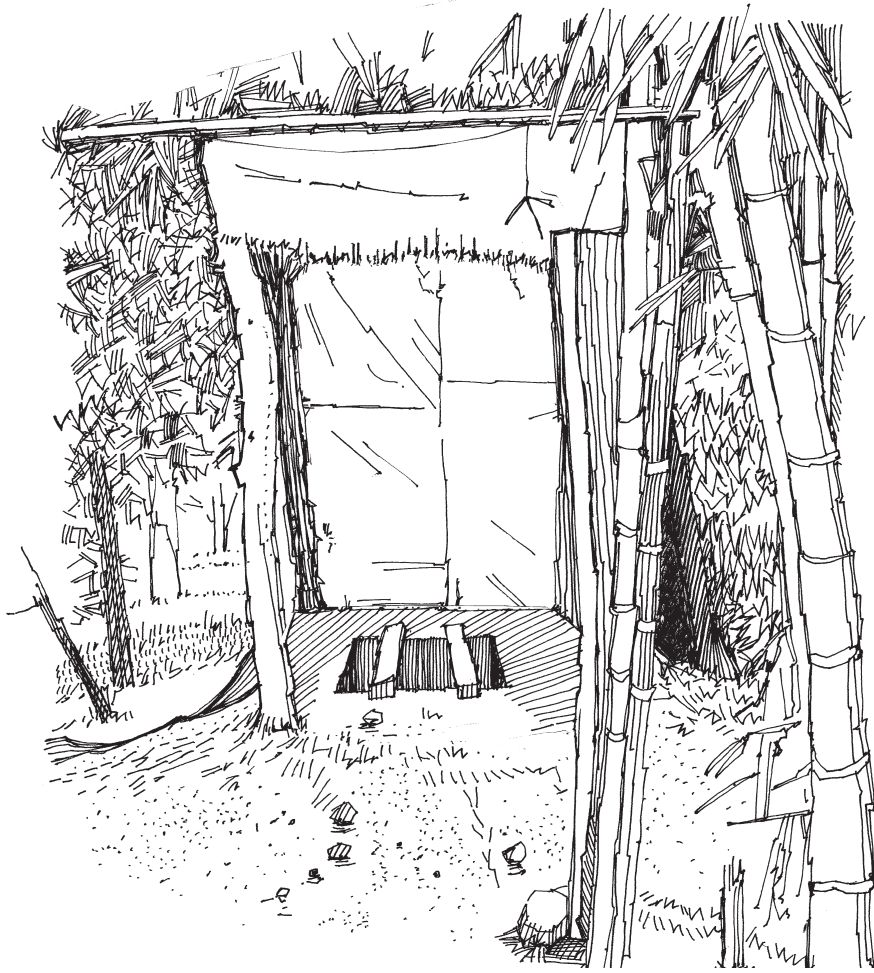

Simple pit latrine

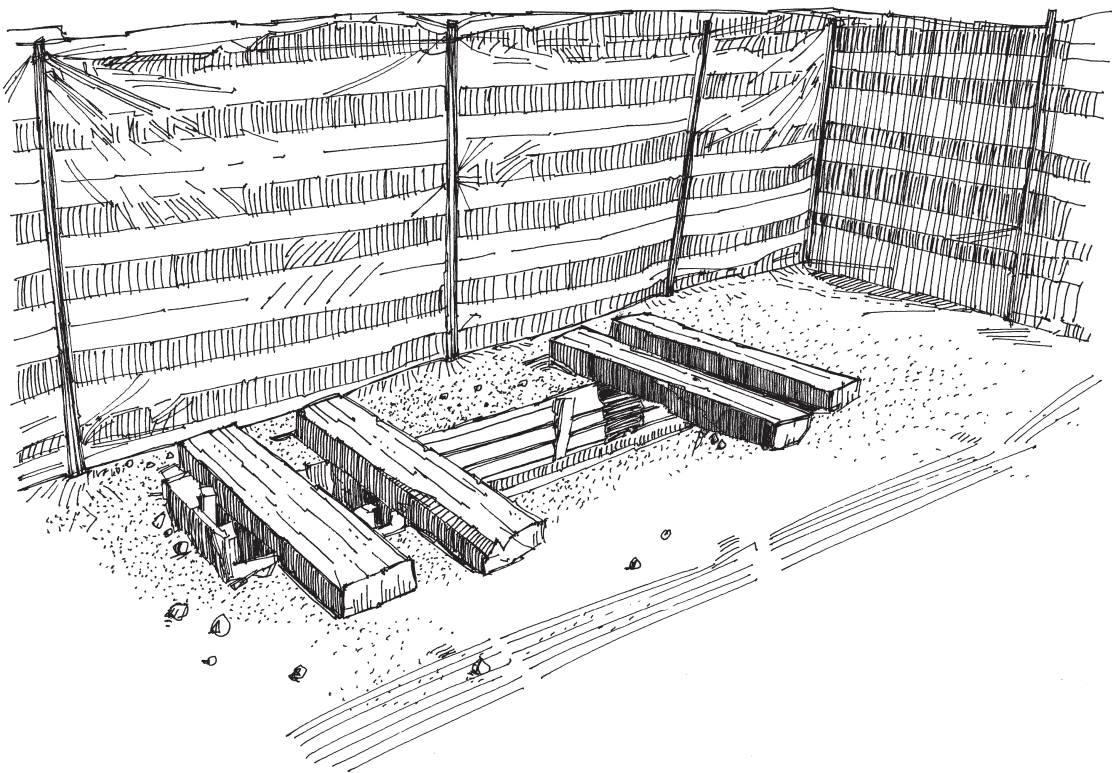

Trench latrines

**S7 - Pit latrine without slab**

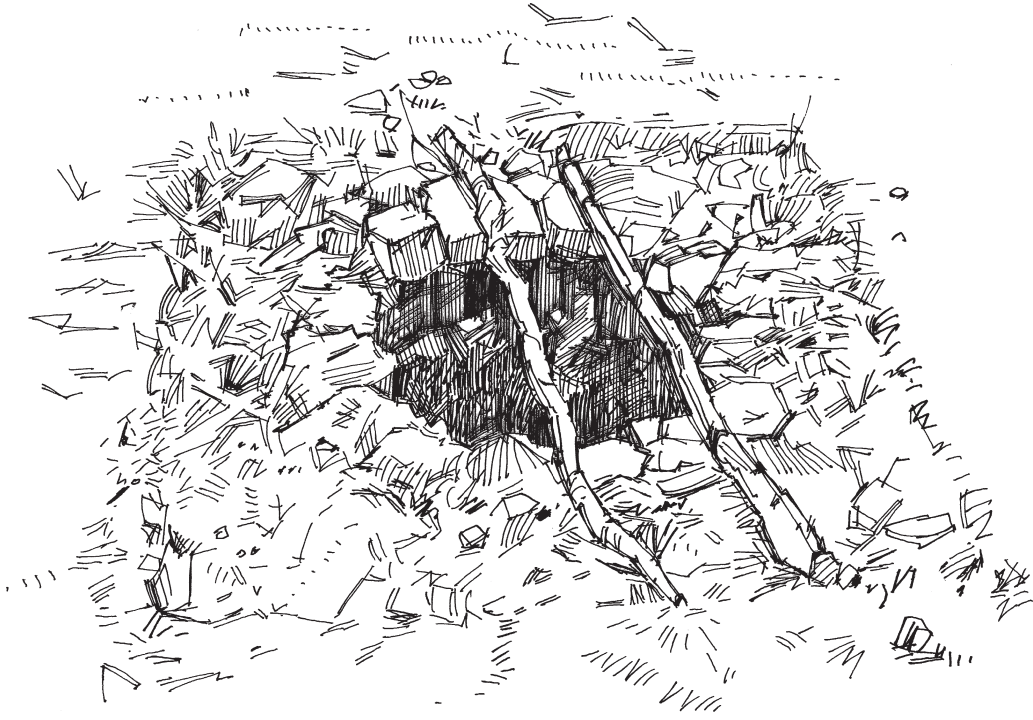

Open pit with sticks

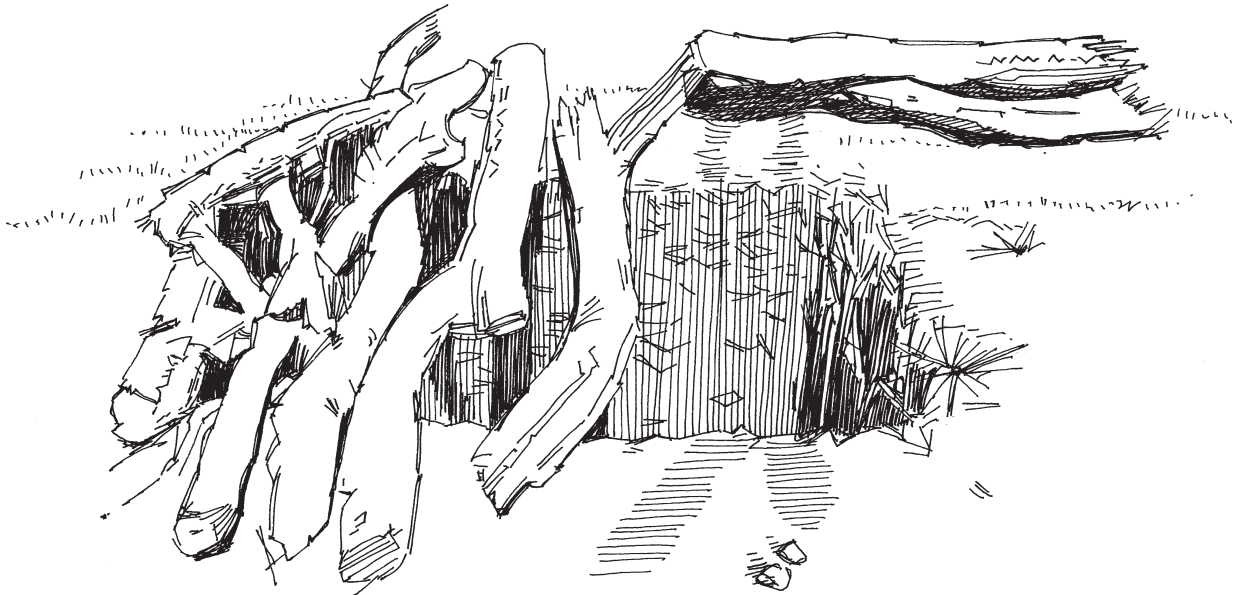

Open pit with logs

**S7 - Pit latrine without slab**

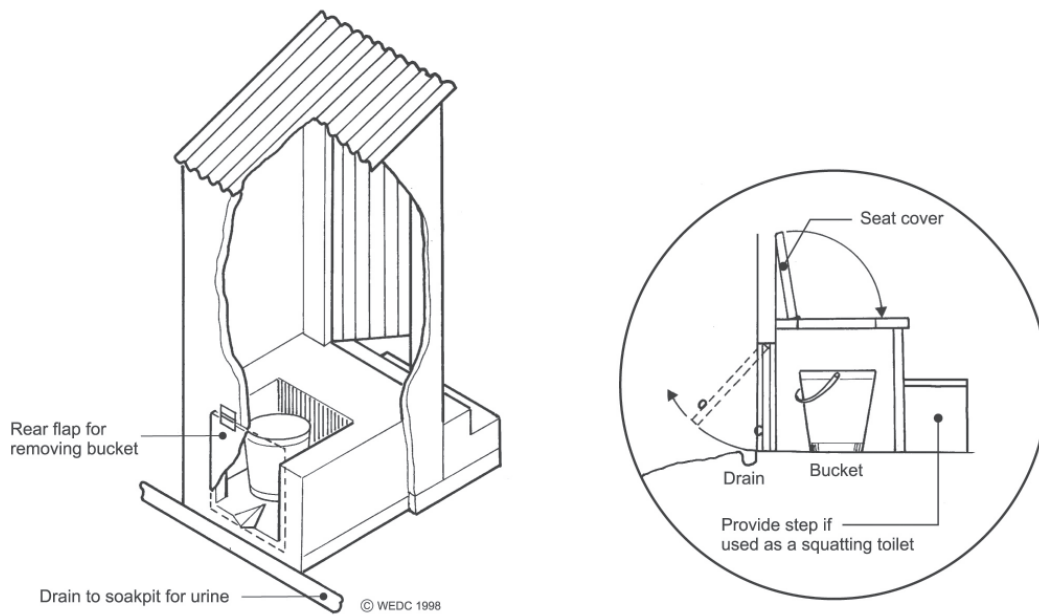

Bucket latrine

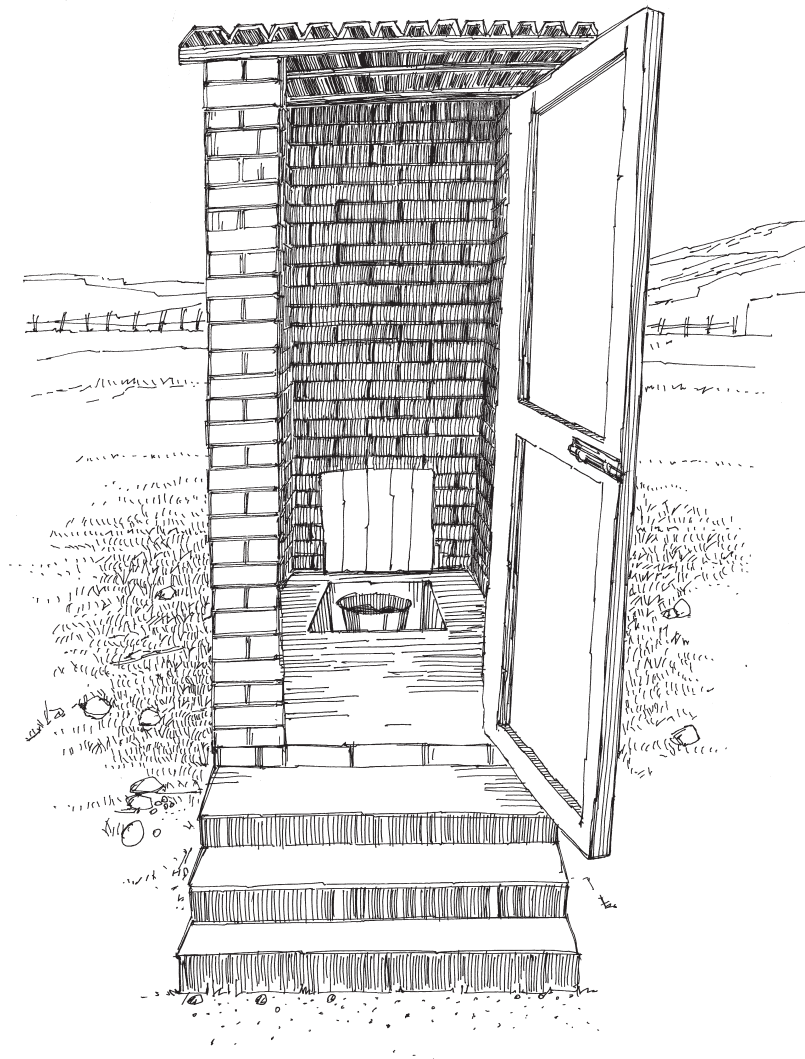

Bucket latrine 1

**S8 - Bucket latrine**

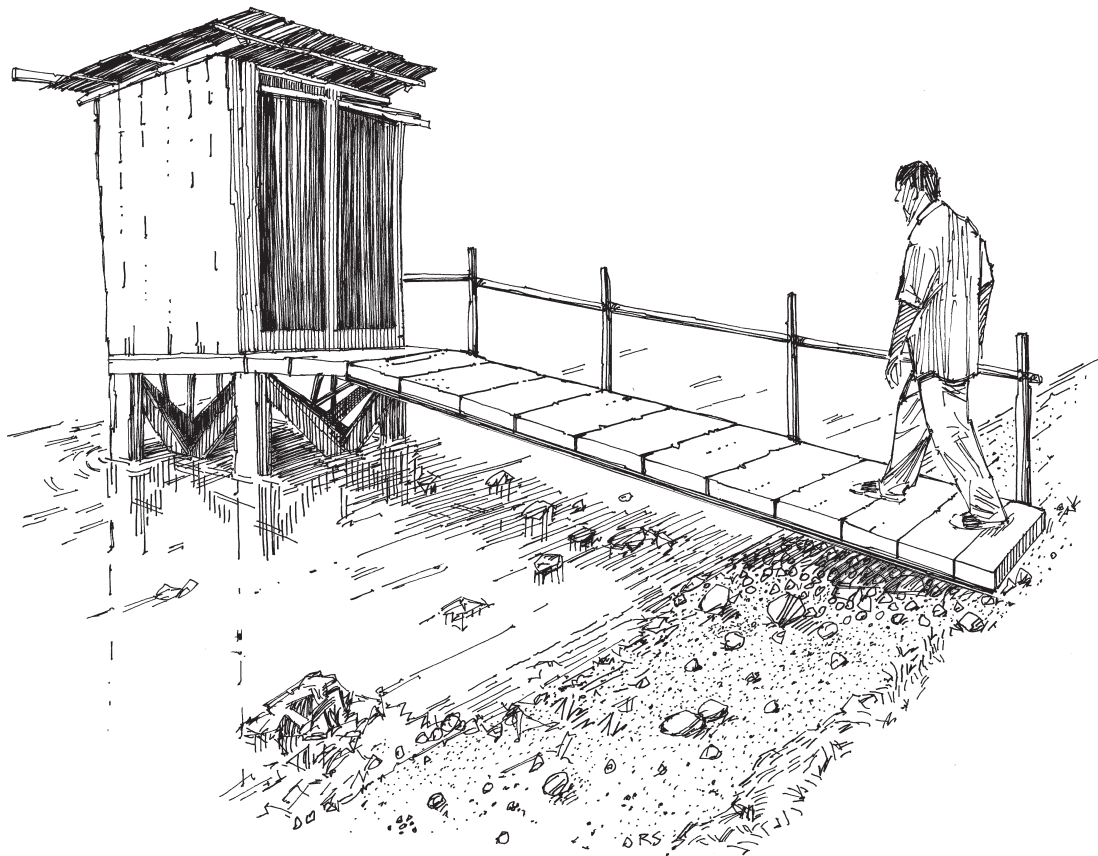

Overhanging latrine 1

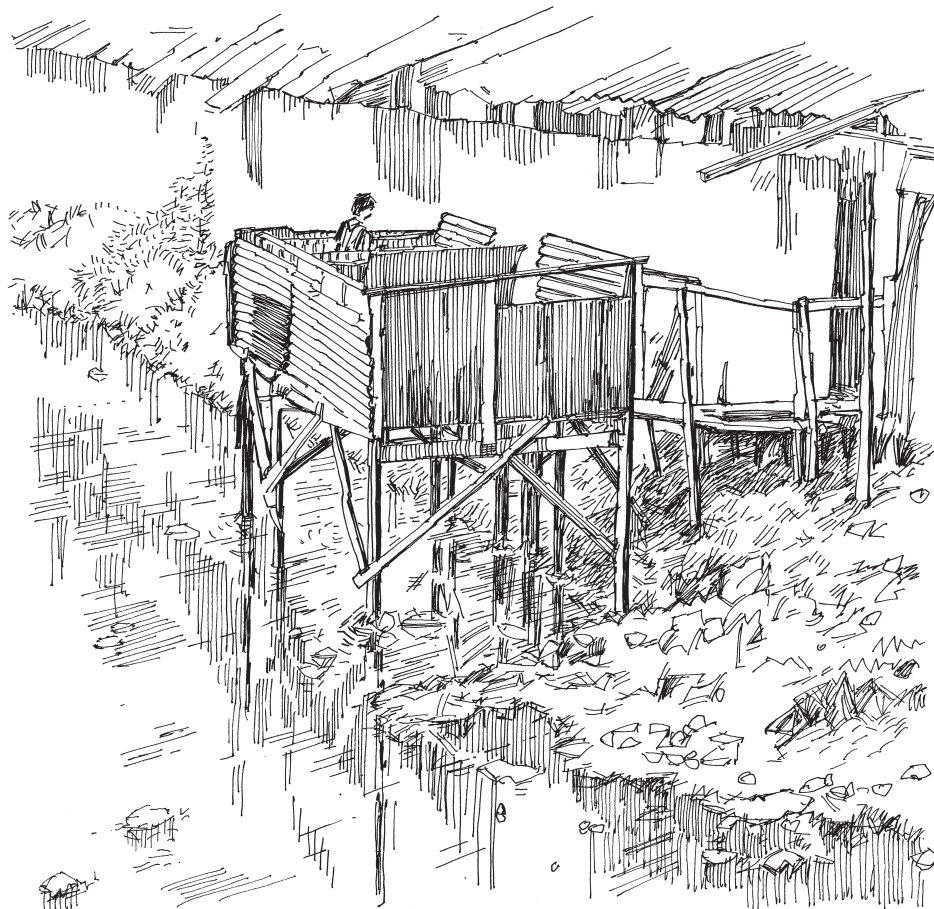

Overhanging latrine 2

### S9 - Overhanging latrine



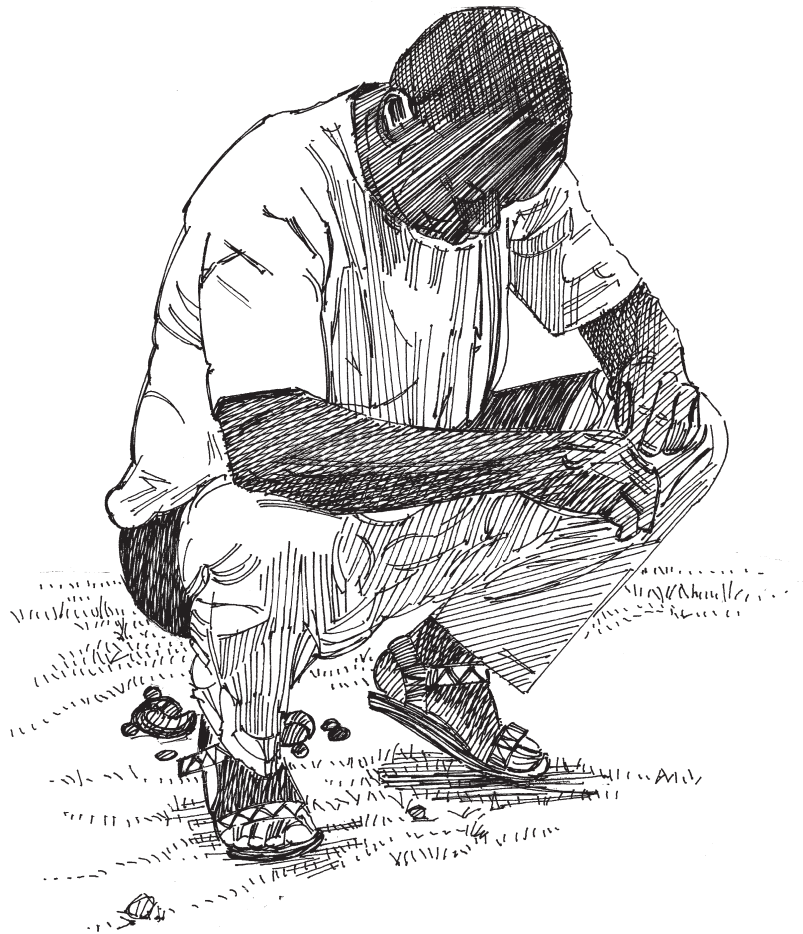

Open defecation



Child with diarrhoea

**S10 - Open defecation**